



# EKIPA

0094NOTIC6116



## AMENAGEMENT PLACARD

B

Col 60

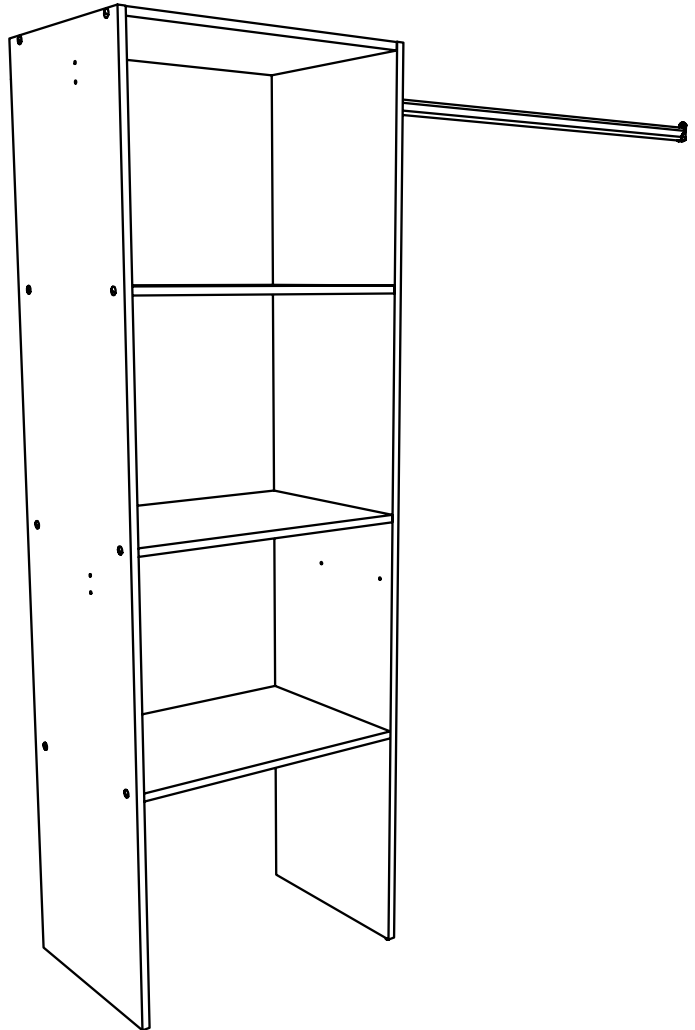
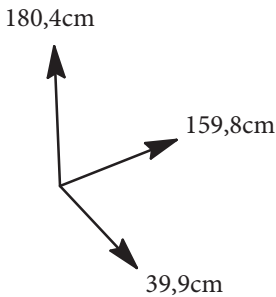
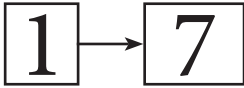

**FR Remerciements :**  
Nous vous remercions d'avoir  
choisi un meuble créé et fabriqué  
par Ekipa et espérons qu'il vous  
donnera entière satisfaction.

**EN Thanks :**  
Thank you for choosing furniture  
designed and manufactured by  
Ekipa. We hope you are totally  
satisfied your purchase.

**ES Agradecimientos :**  
Les damos las gracias por haber  
elegido un mueble diseñado y  
fabricado por el Ekipa y esperamos  
que sea de su total agrado.

**DE Danksagung:**  
Wir danken Ihnen für den Kauf eines  
Frankreich von der Ekipa  
entworfenen und hergestellten Möbelstücks  
und hoffen, dass Sie es zu Ihrer  
vollkommenen Zufriedenheit finden werden.



Temps de montage : 1h00



contact@parisot.com



### Conseils de préparation au montage : 15 min

video conseil  
<https://qrco.de/bcJeNz>

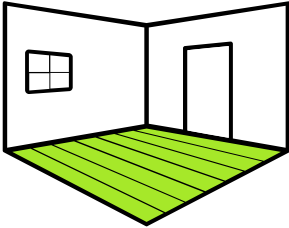

Faire un peu de place

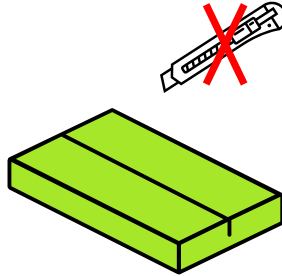

Pas d'outils tranchants

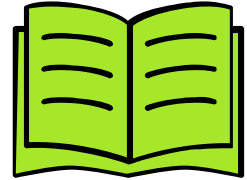

Bien suivre les instructions de la notice de montage

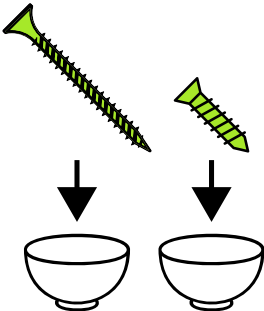

Trier vos quincailleries

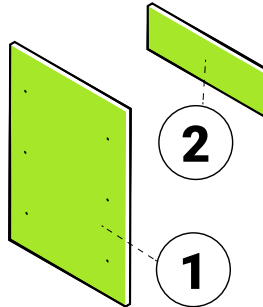

Repérer vos pièces

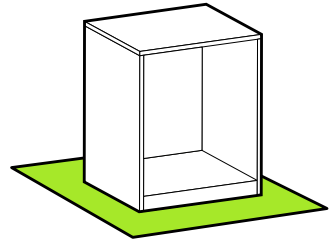

Protéger votre sol

### Matériel nécessaire

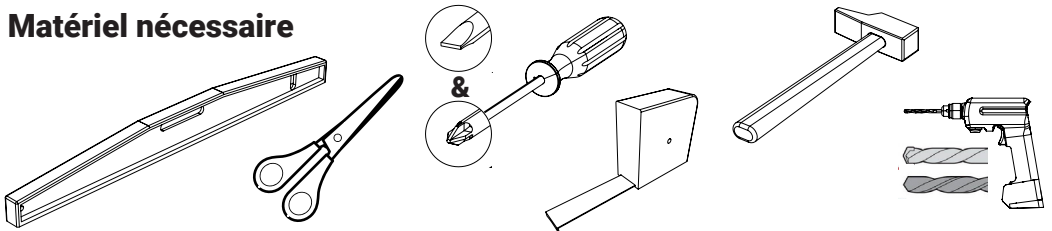

### Conseils d'entretien

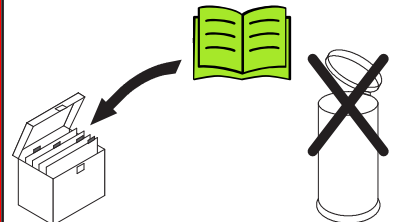

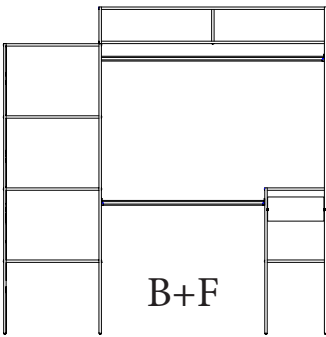
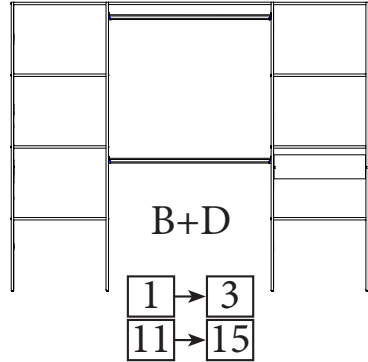
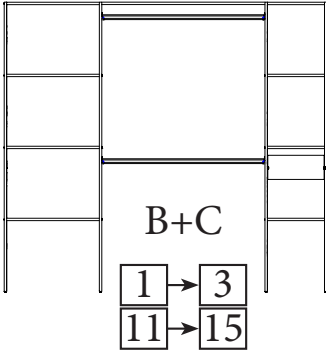
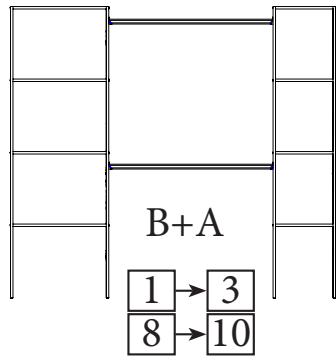
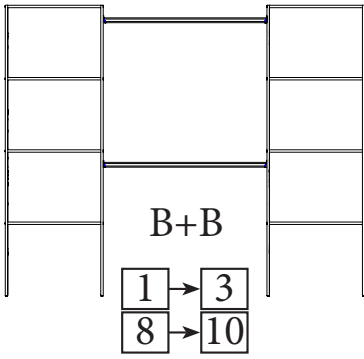

Voir notice F

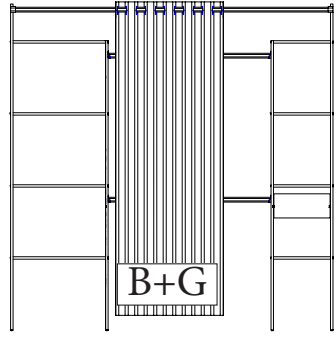

Voir notice G

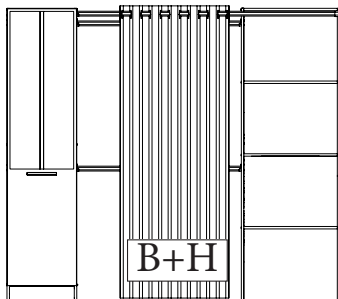

Voir notice H

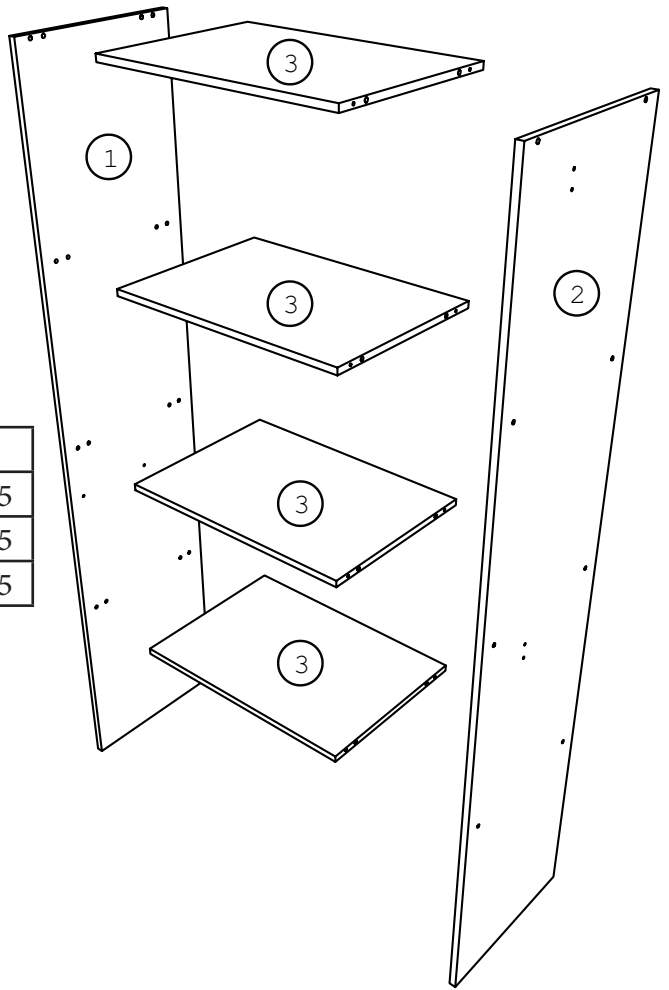

Rep	Qté	cm		
01	1	180	39,9	1,5
02	1	180	39,9	1,5
03	4	56,8	39,8	1,5

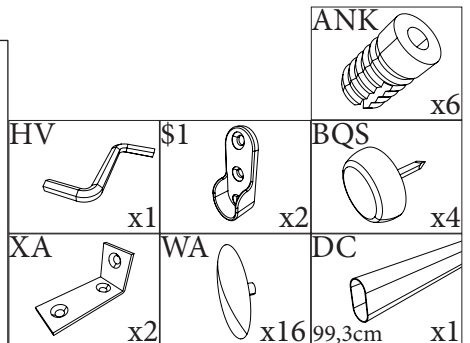
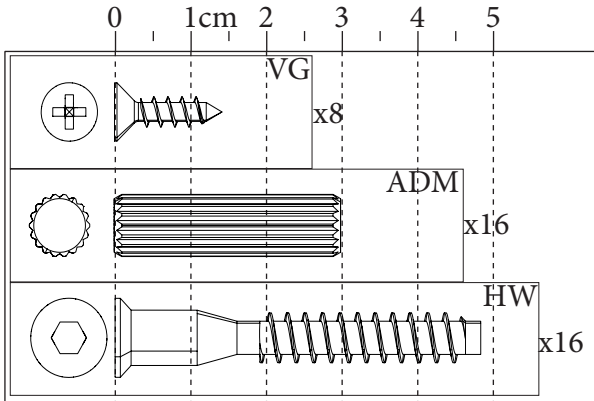

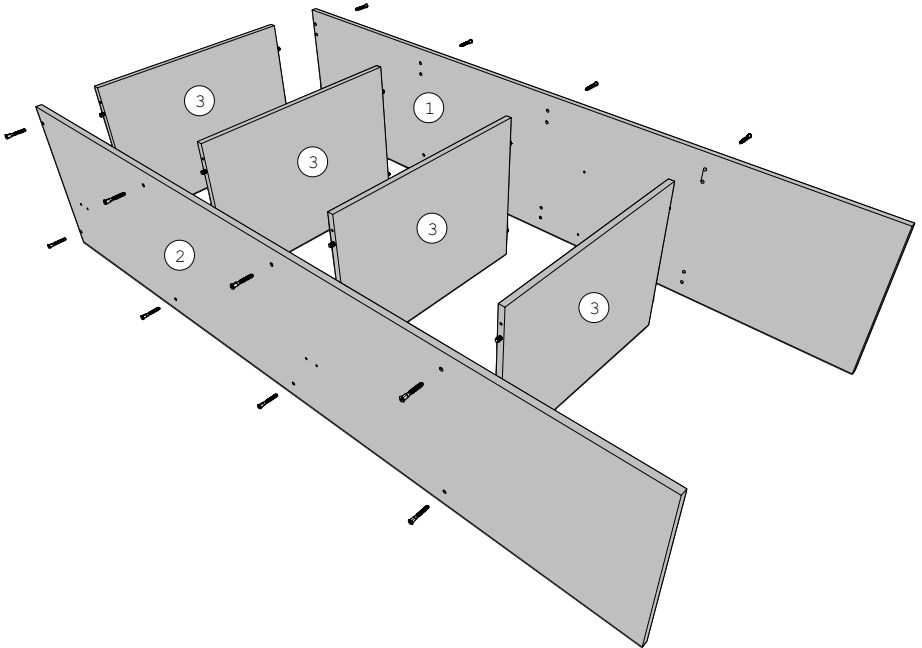
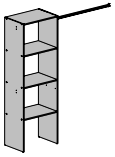
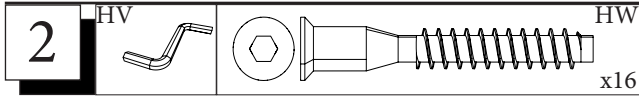
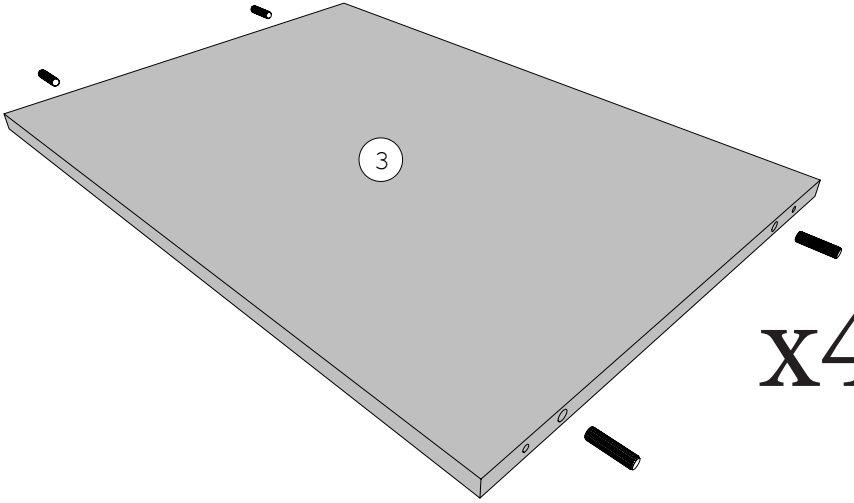
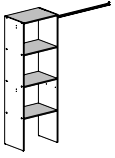
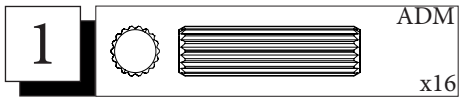

3 BQS x4

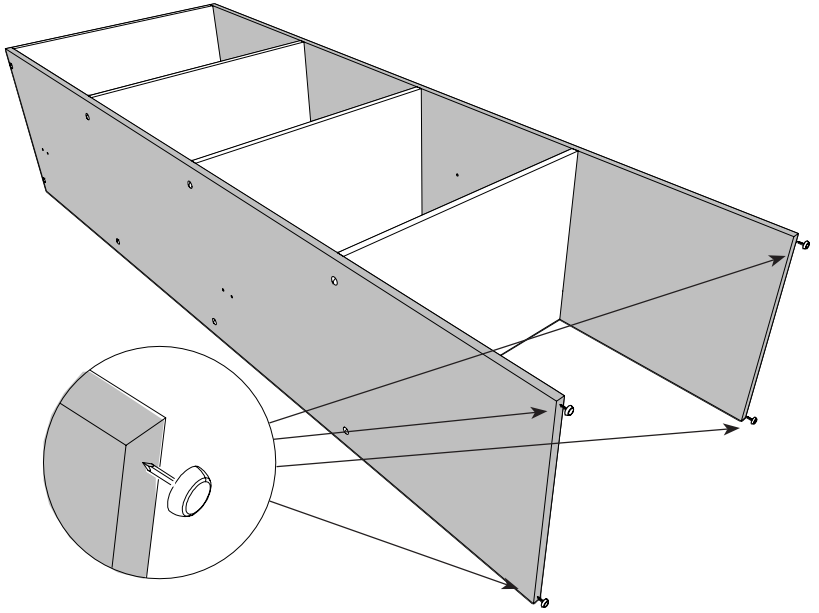
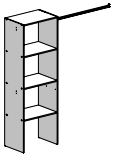

4

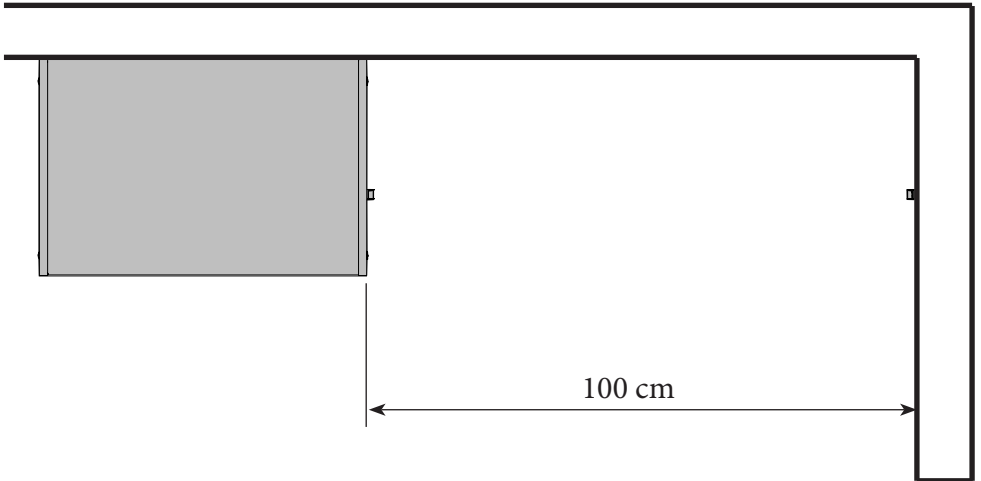
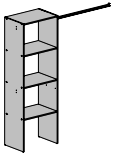

5

XA

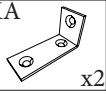

x2



VG

x4

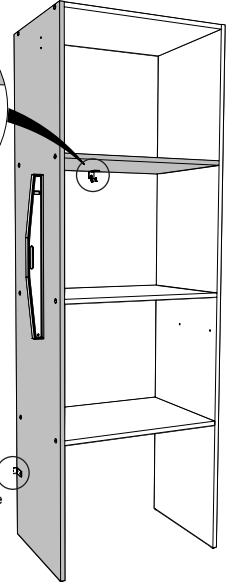
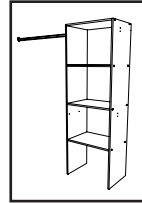
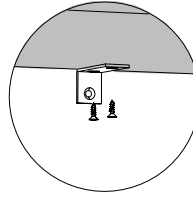
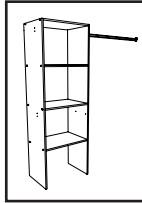
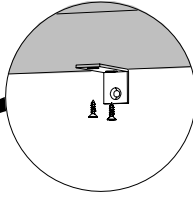
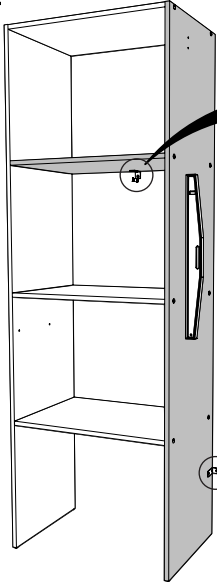
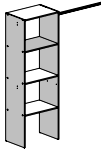

FR

FR Pour votre sécurité : Fixation du meuble au mur.  
Attention, la fixation doit être réalisée par une personne compétente  
car cela nécessite des chevilles adaptées à la nature de votre mur.

EN For your safety: the unit should be secured to the wall.

NB this should be carried out by a competent person as you must  
use the right rawplug for your type of wall.

6

ANK



x2



VG\$1

x2



x1

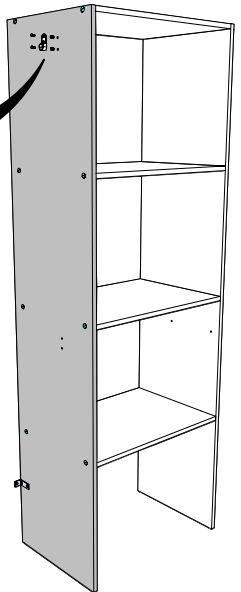
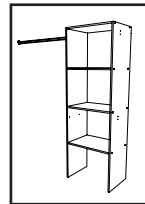
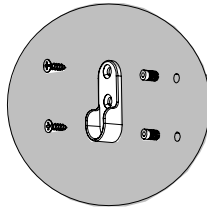
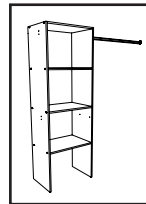
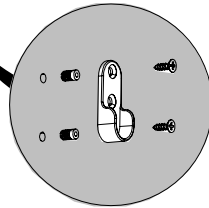
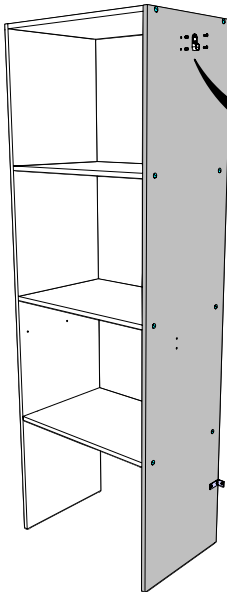
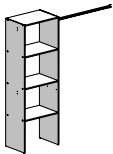

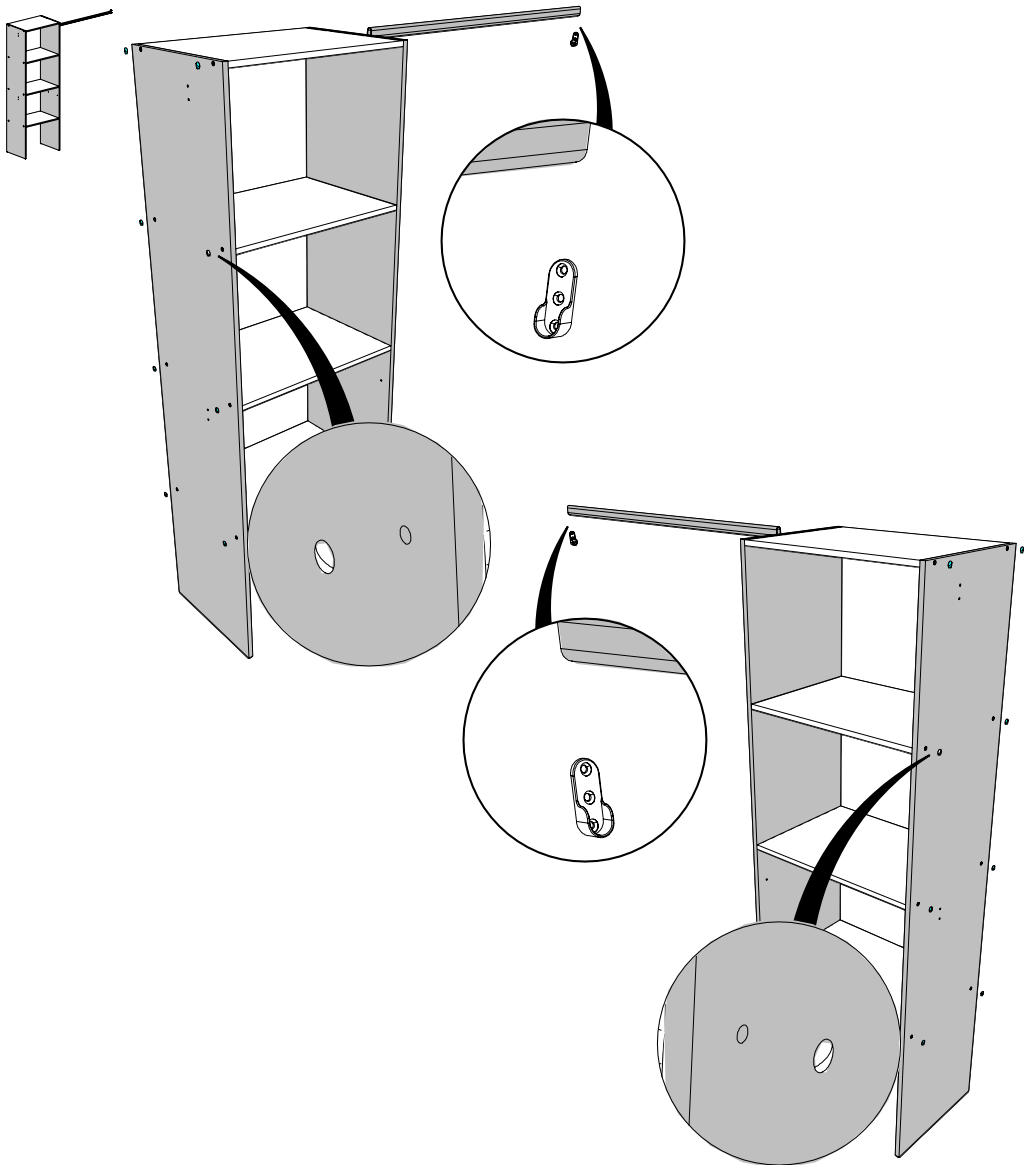
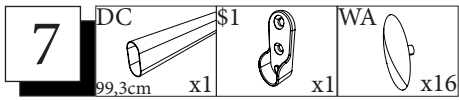

FR Pour votre sécurité : Fixation du meuble au mur  
 Attention, la fixation doit être réalisée par une personne compétente  
 car cela nécessite des chevilles adaptées à la nature de votre mur.

EN For your safety: the unit should be secured to the wall.  
 NB this should be carried out by a competent person as you must  
 use the right rawplug for your type of wall.



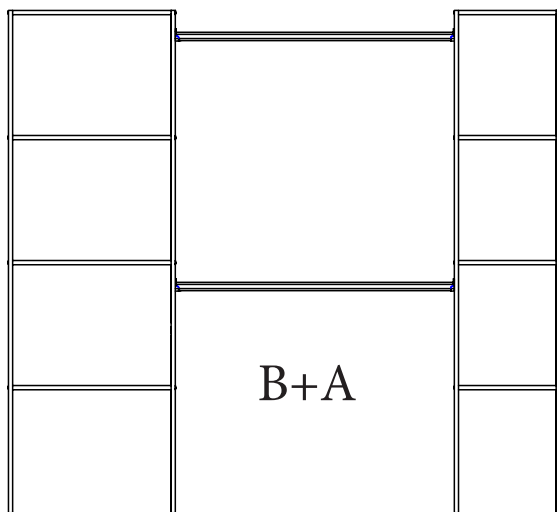
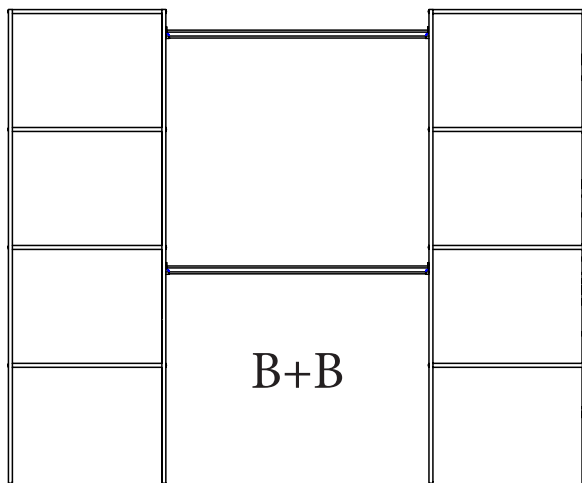

8



VGXA



x8

x4

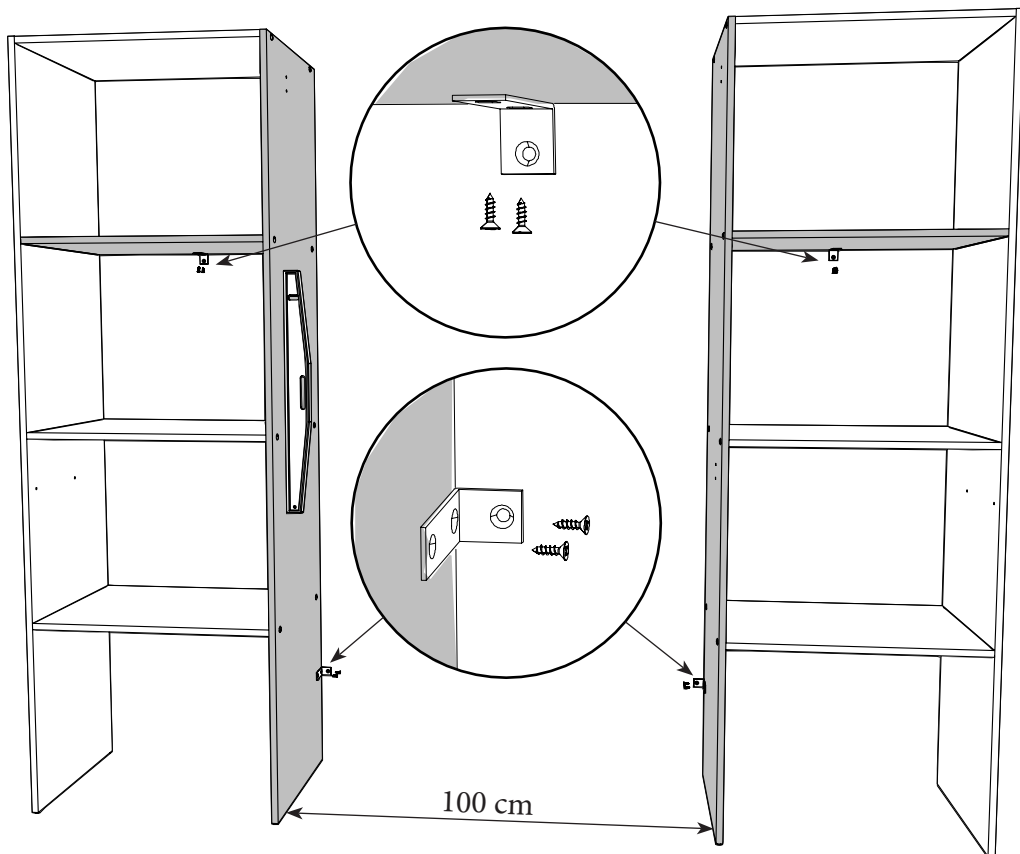
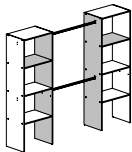

FR Pour votre sécurité : Fixation du meuble au mur

Attention, la fixation doit être réalisée par une personne compétente car cela nécessite des chevilles adaptées à la nature de votre mur.

EN For your safety: the unit should be secured to the wall.

NB this should be carried out by a competent person as you must use the right rawlplug for your type of wall.

9



VG\$1



x8

x4

x8

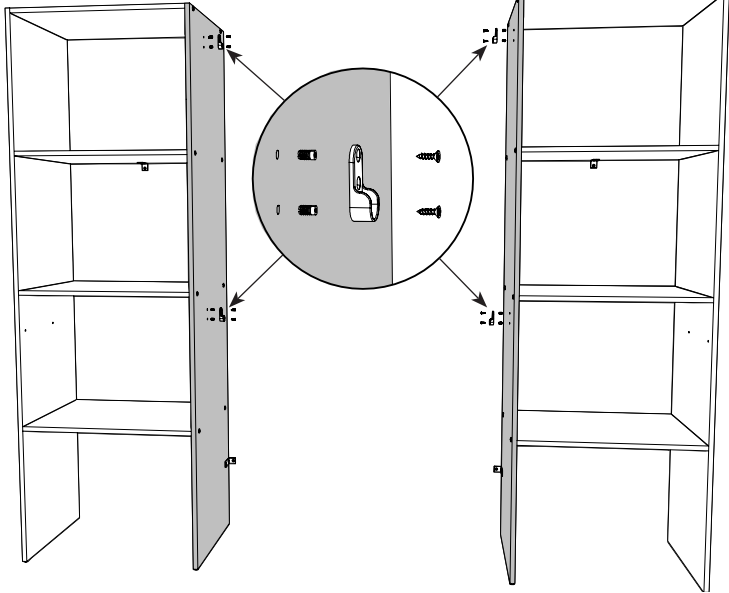
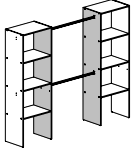

10

DC



WA



99,3cm

x2

x32

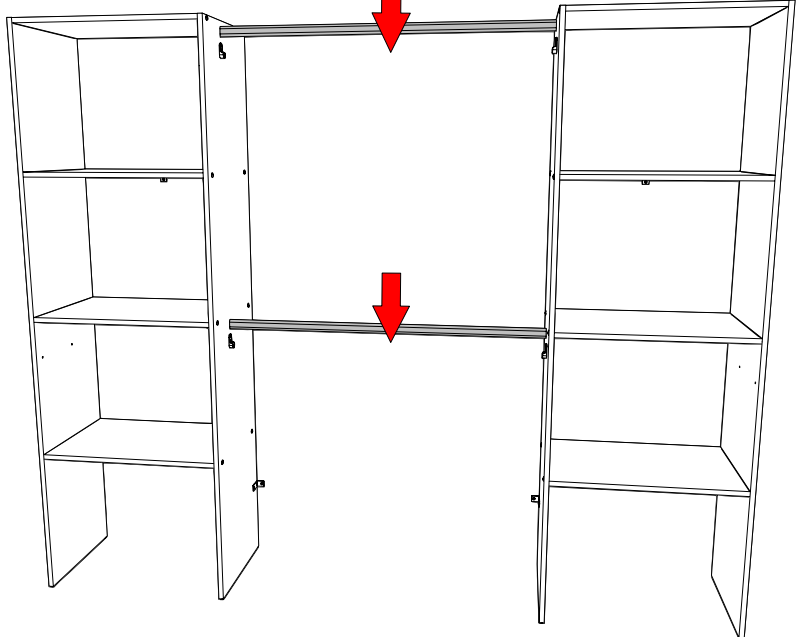
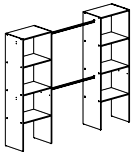

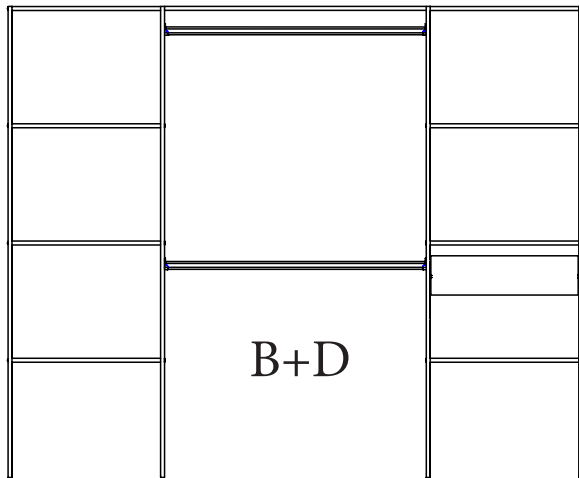
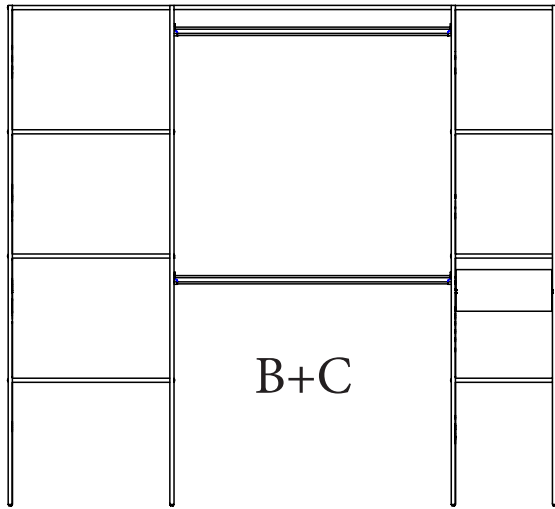

11



VG CIF



x4

x2

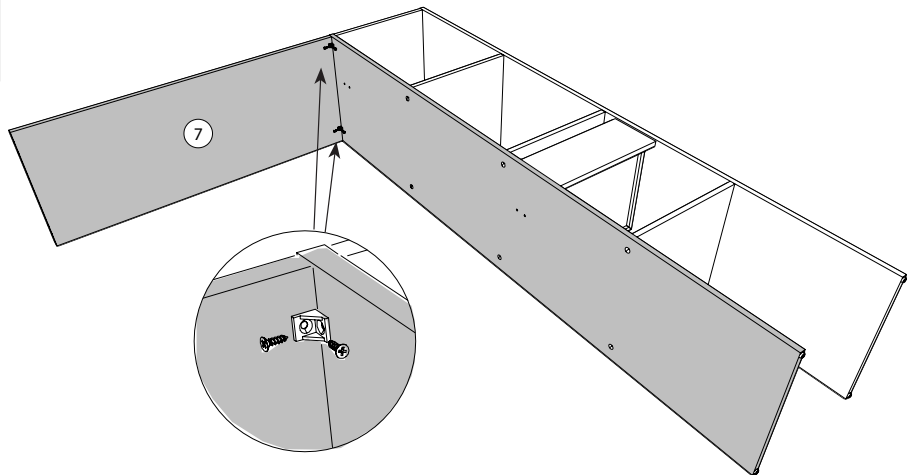
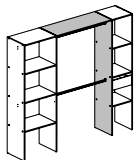

12



VGXC



x8

x2

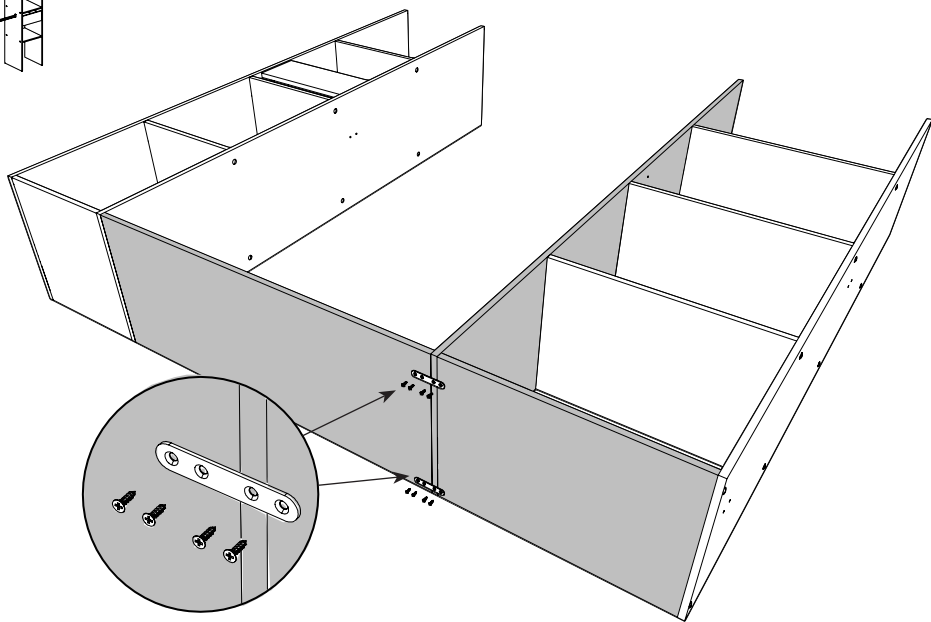
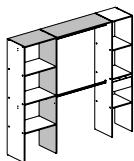

13



VGXA



x10

x5

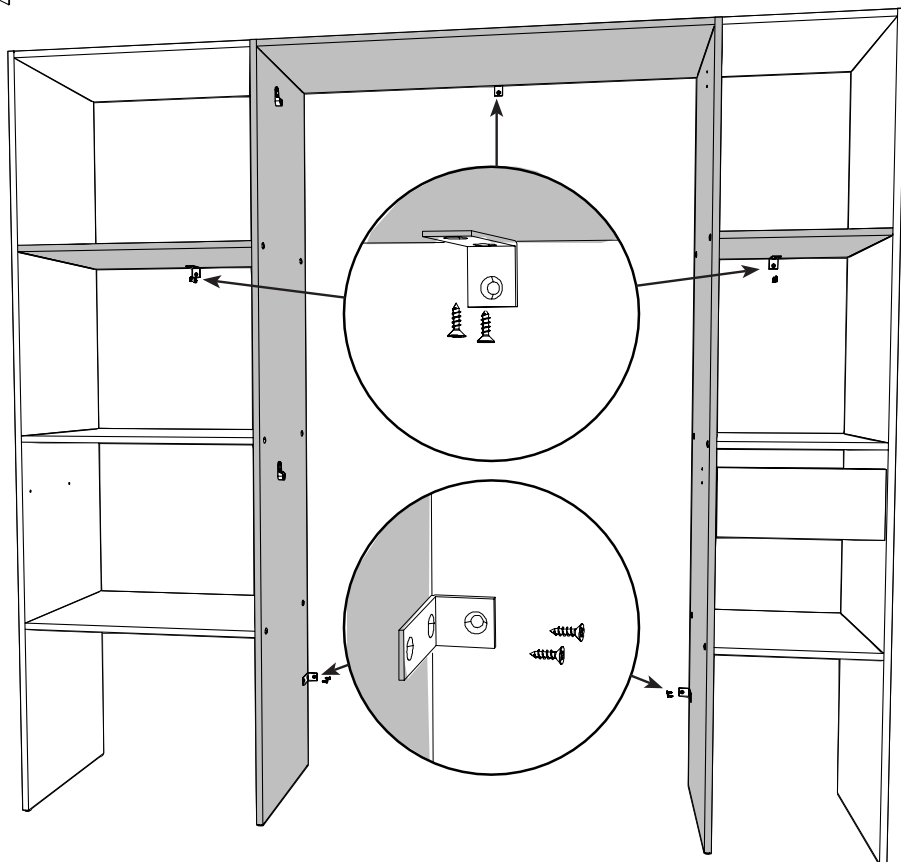
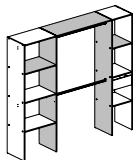

FR Pour votre sécurité : Fixation du meuble au mur

Attention, la fixation doit être réalisée par une personne compétente car cela nécessite des chevilles adaptées à la nature de votre mur.

EN For your safety: the unit should be secured to the wall.

NB this should be carried out by a competent person as you must use the right rawlplug for your type of wall.

14

\$1



x4

ANK



x8



VG

x8

