



44 Avenue Paul Girard  
10500 DIENVILLE  
FRANCE  
www.sciae.com

# AROLLA

INDICE A - 25/01/2022  
AROLLA 0636 ILOT CENTRAL 2PO N°16 Réf: 21SD4220

EAN: 3102000112404

**NOTICE DE MONTAGE**  
ASSEMBLING INSTRUCTIONS  
MONTAGEANLEIUNG  
MANUAL DE MONTAJE  
MONTAGEVOORSCHRIFT  
INSTRUÇÕES DE MONTAGEM  
ISTRUZIONI DI MONTAGGIO  
ИНСТРУКЦИЯ ПО СБОРКЕ  
Naputci za montažu

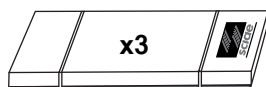
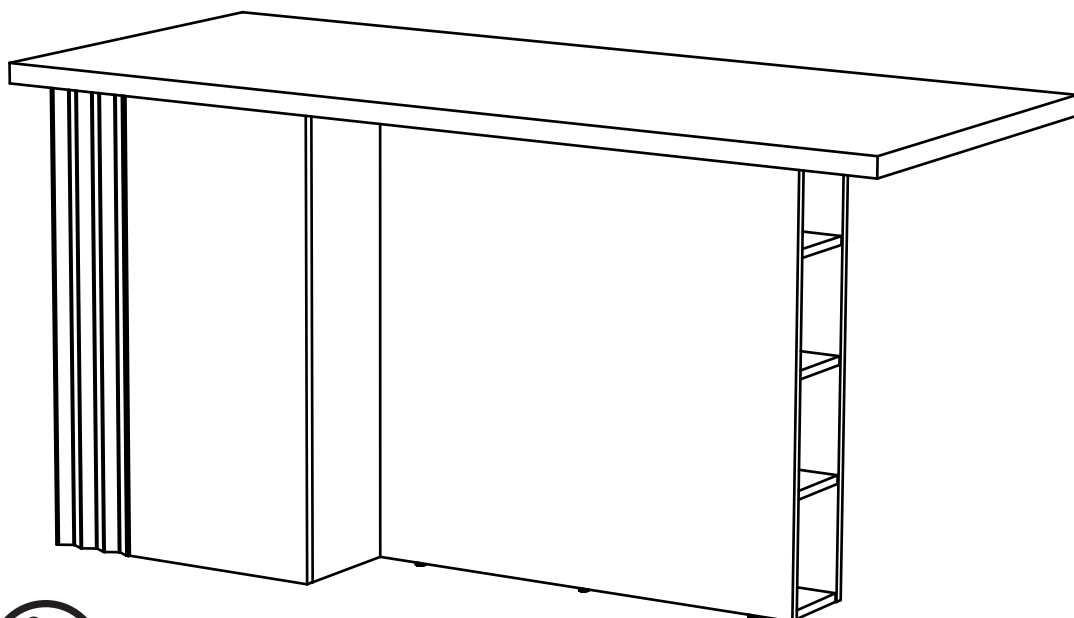

Package 1: 28.5 Kg  
Package 2: 32.5 Kg  
Package 3: 33.5 Kg





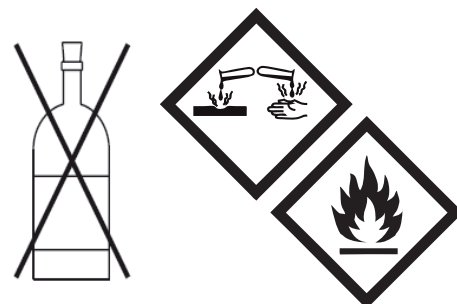
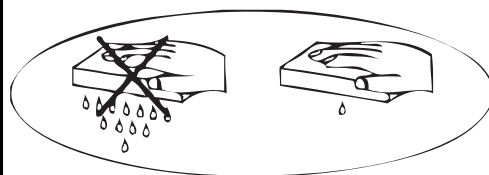



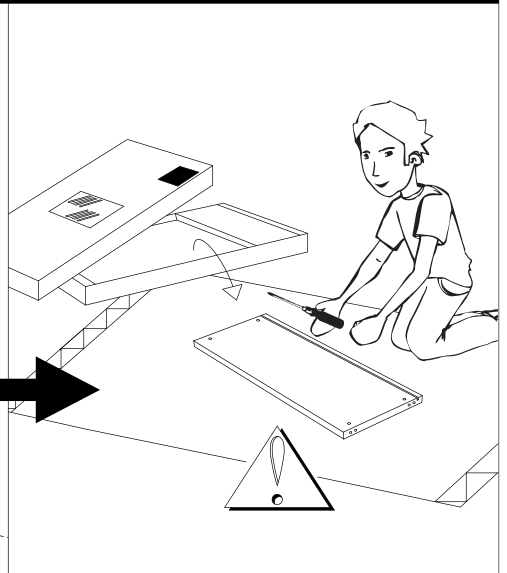
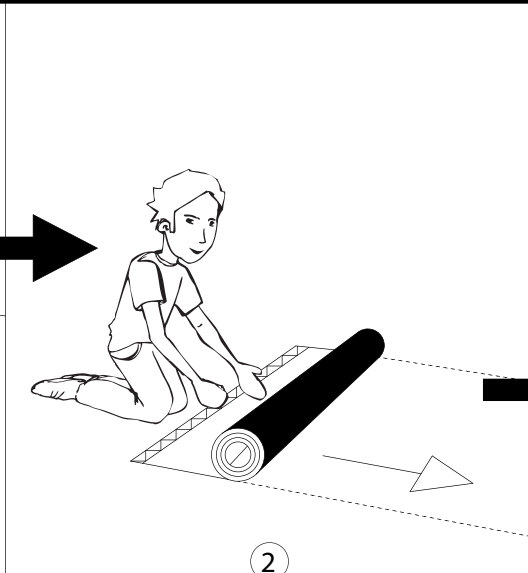
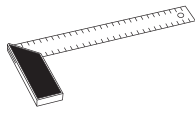
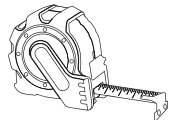
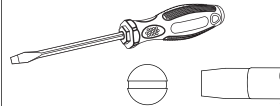
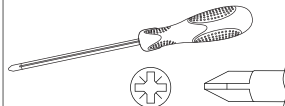
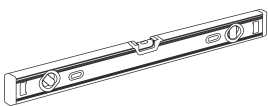
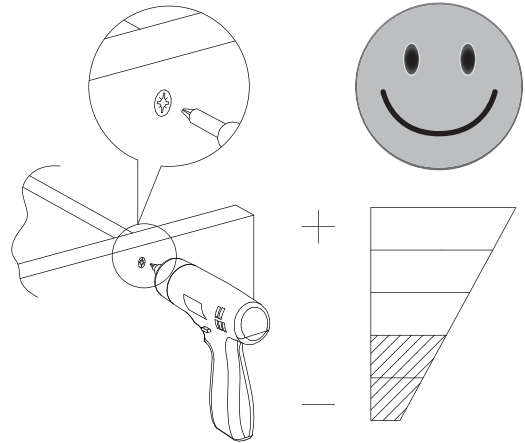
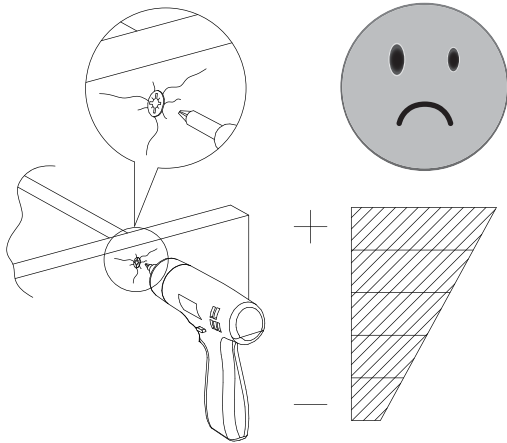
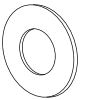
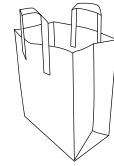
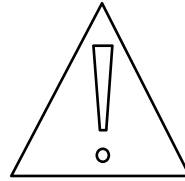

- F** POUR L'APRES-VENTE, RETOURNEZ AU MAGASIN AVEC CETTE NOTICE
- GB** FOR THE AFTER SALES, GO BACK TO THE SHOP WITH THIS ASSEMBLY INSTRUCTION
- D** WENDEN SIE SICH BITTE AN IHREN HANDLER UND GEBEN SIE IHM DIE KENNUMMER DES MOBELS UND DIE TEILNUMMER
- E** EN CASO DE SERVICIO POST-VENTA DEBEN DE VOLVER A LA TIENDA CON LAS INSTRUCCIONES DE MONTAJE
- NL** VOOR SERVICE NA VERKOOP, GA NAAR UW LEVERANCIER MET DEZE MONTAGE HANDLEIDING
- P** PARA O POS VENDA, VOLTE A LOJA COM ESTA FOLHA
- I** SERVIZIO POST VENDITA: E NECESSARIO PRESENTARSI SUL PUNTO VENDITA CON QUESTE ISTRUZIONI DI MONTAGGIO
- RU** ДЛЯ ПОСЛЕПРОДАЖНОГО ОБСЛУЖИВАНИЯ ПРОСЬБА ОБРАТИТЬСЯ В МАГАЗИН ПРЕДЪЯВИВ НАСТОЯЩУЮ ИНСТРУКЦИЮ ПО СБОРКЕ
- HR** U SLUČAJU REKLAMACIJE, VRATITE SE NA PRODAJNO MJESTO S OVIM UPUTAMA ZA MONTAŽU

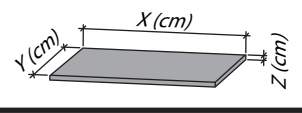
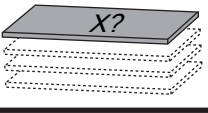
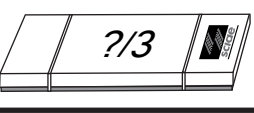

	+40°C +104°F	
	HYGROMETRIE HYGROMETRY 40%-65%	
	+15°C +59°F	

	1 an 1 year		

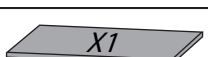
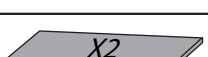
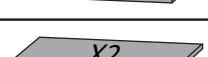

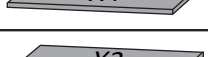
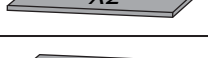
<i>DESIGNATION</i>		N°		
Dessous	63.5 x 36.4 x 1.6	1		1
Côté gauche	87.2 x 63.7 x 1.6	2		2
Séparation avant	87.2 x 87.2 x 1.6	3		2
Intermédiaire séparateur	87.2 x 14.8 x 1.6	4		2
Séparateur arrière	87.2 x 87.2 x 1.6	5		2
Côté droit	87.2 x 63.7 x 1.6	7		2
Plateau	180.2 x 75.5 x 3.8	8		3
Tablette	63 x 36.3 x 1.6	9		1
Porte	86.8 x 39.5 x 1.8	10		1
Tablette niche droite	23 x 14.8 x 1.6	19		2
Meneau	87.2 x 16.5 x 2.5	20		1
Tablette niche gauche	62.3 x 16.5 x 2.5	29		1

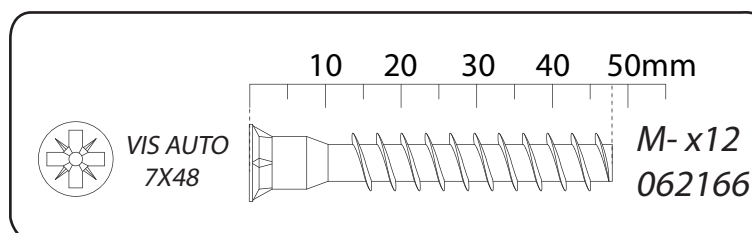
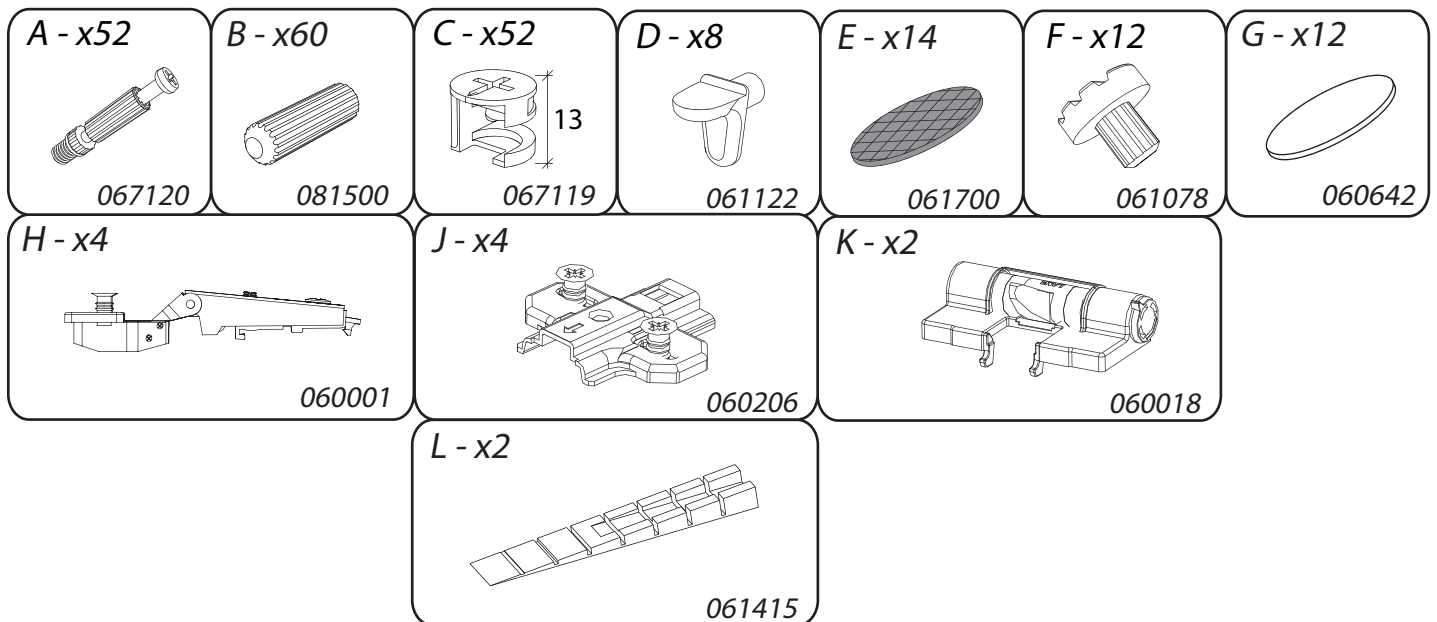

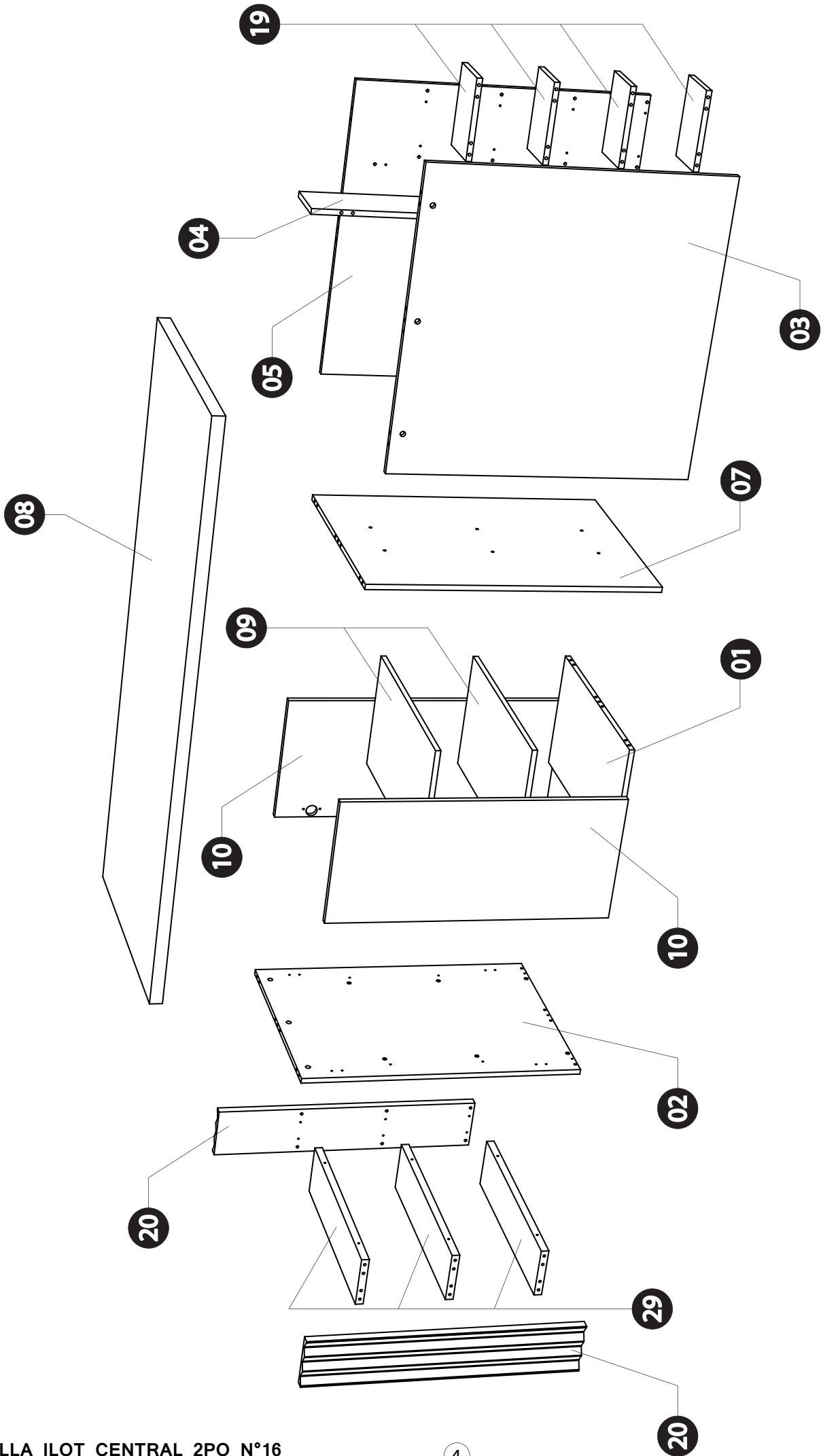

1

A-x12

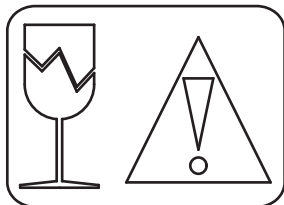
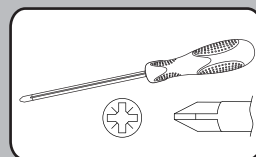
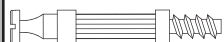

20

20

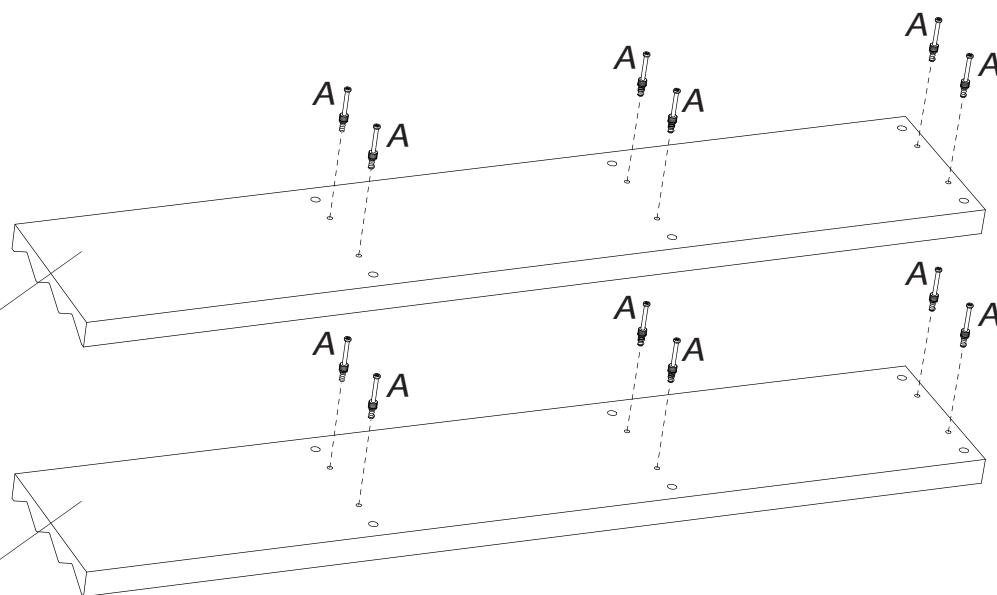

2

C-x12



B-x12

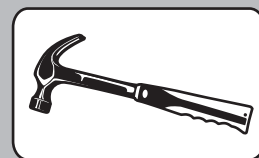

29

29

29

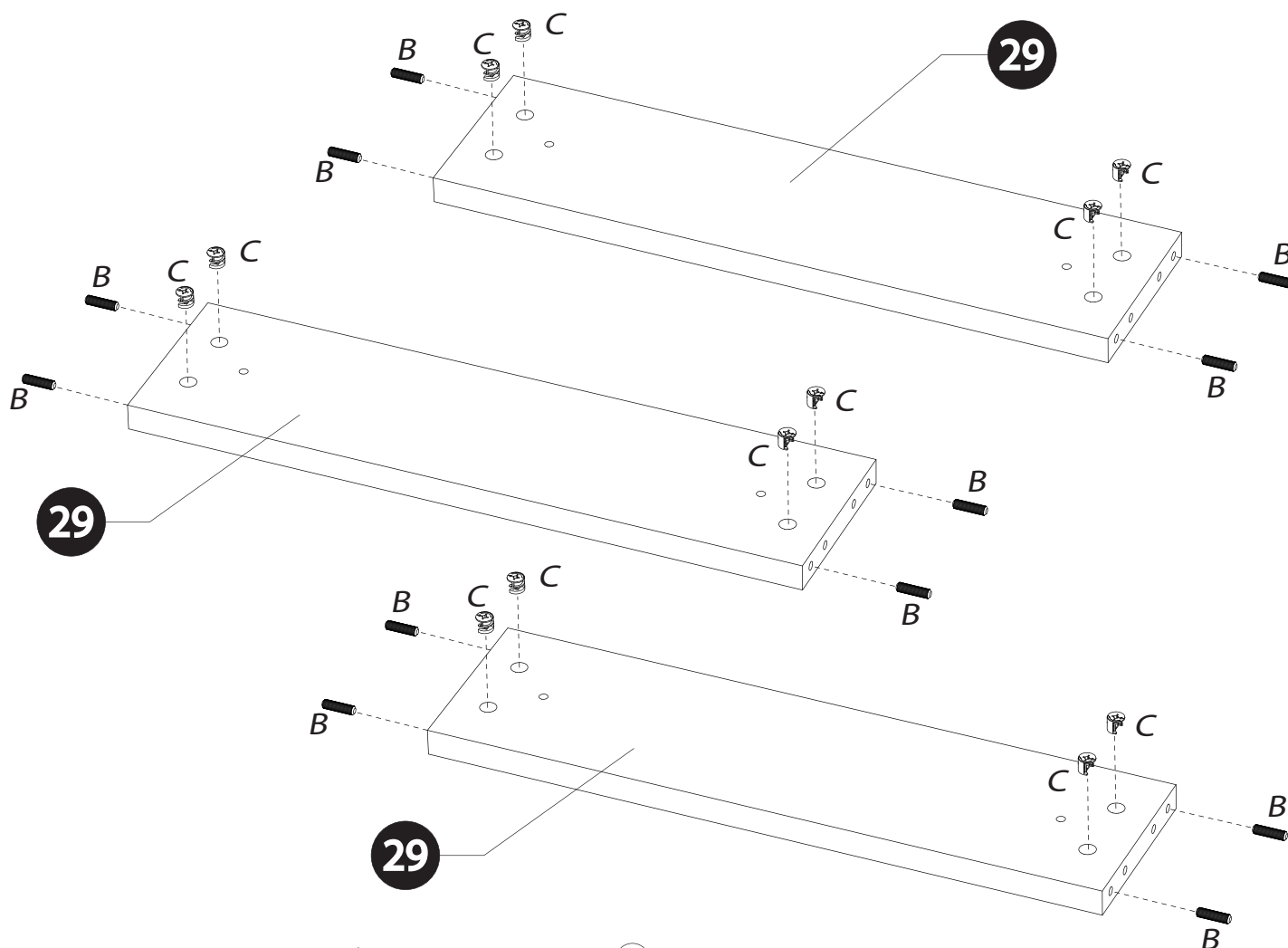

3

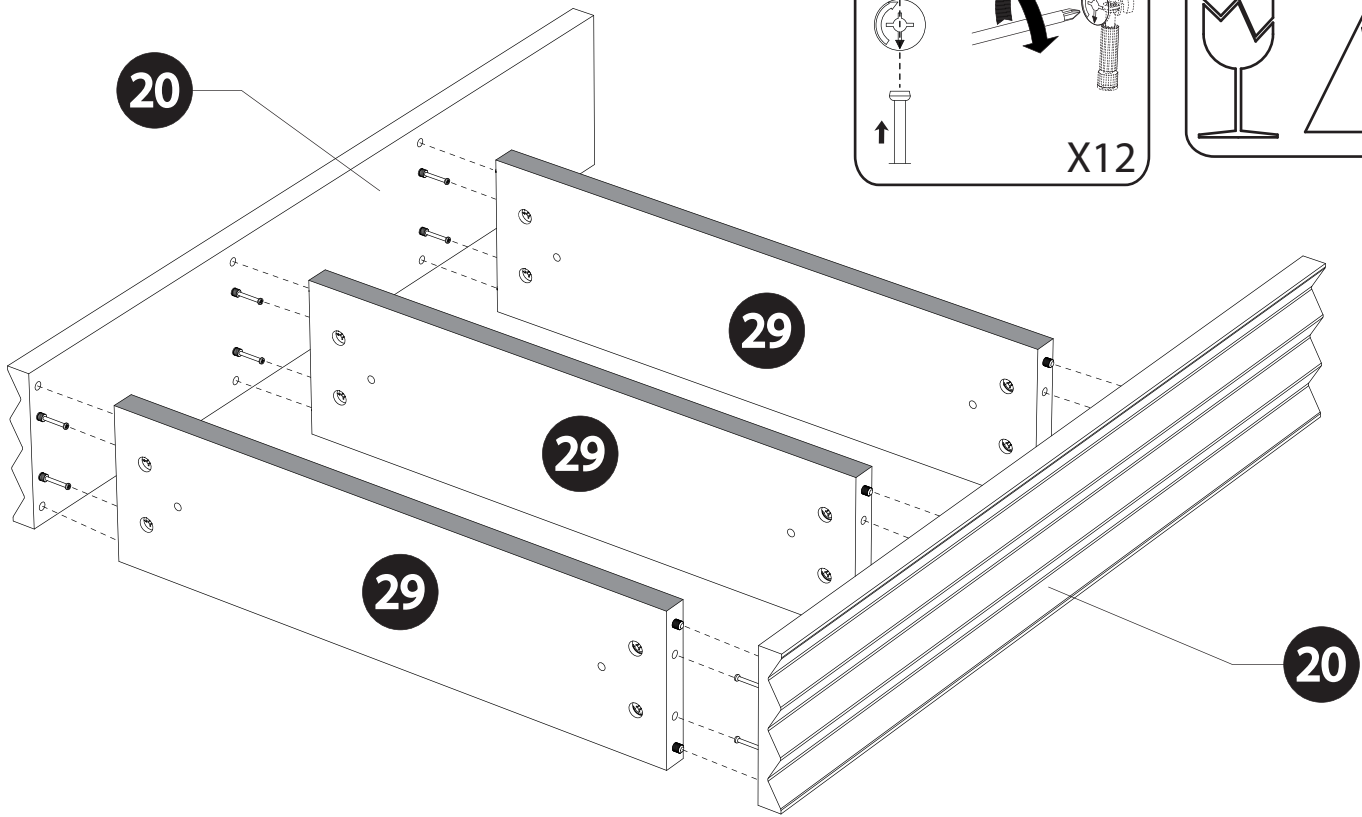
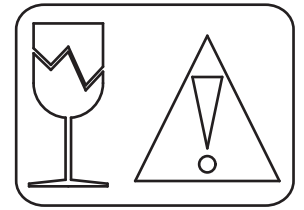
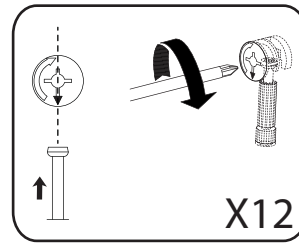
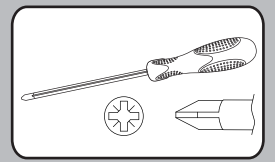

4

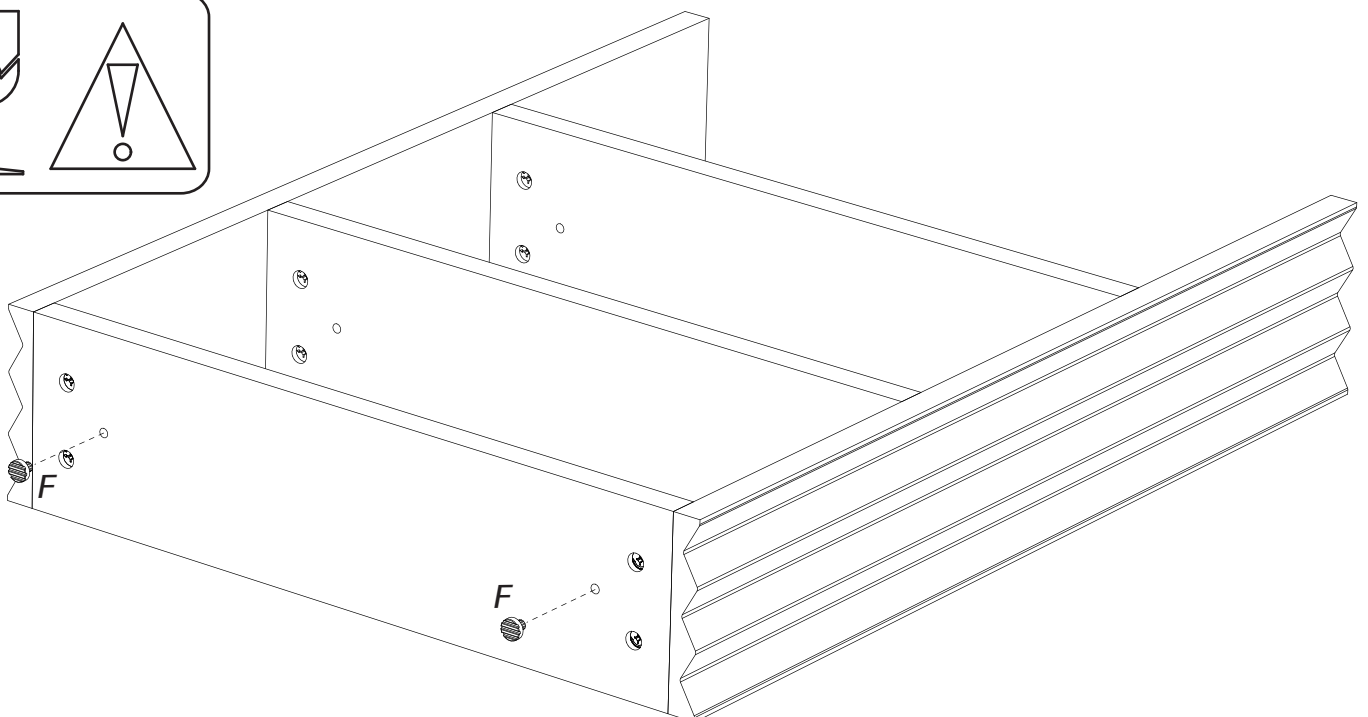
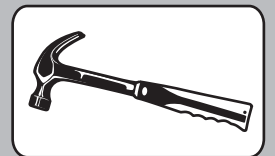
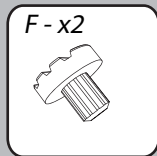

# 5

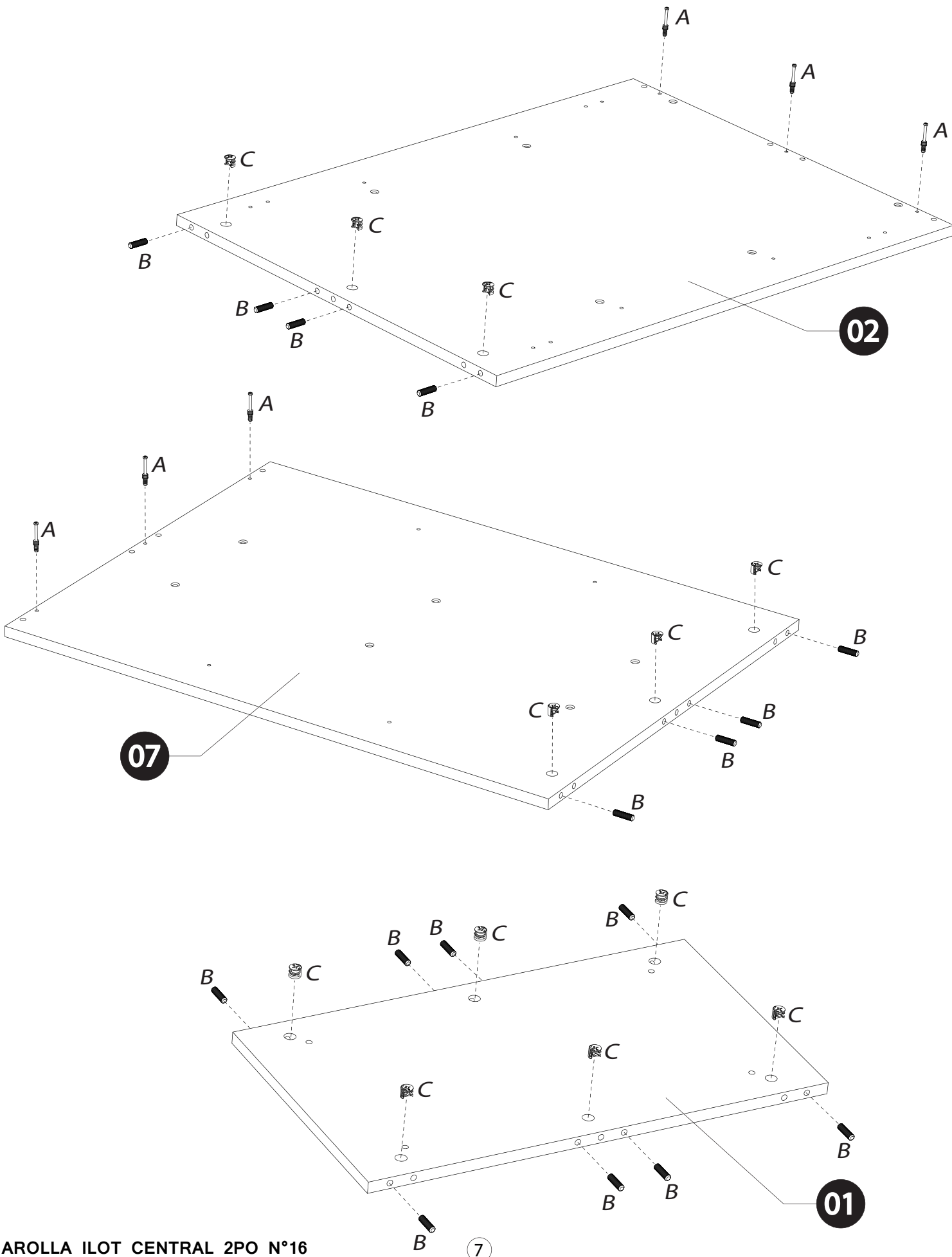
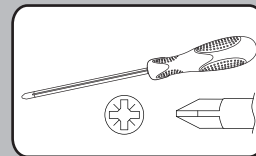
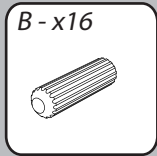
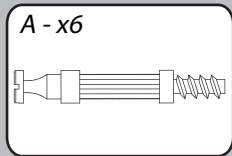
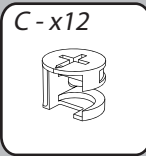

6

F - x4

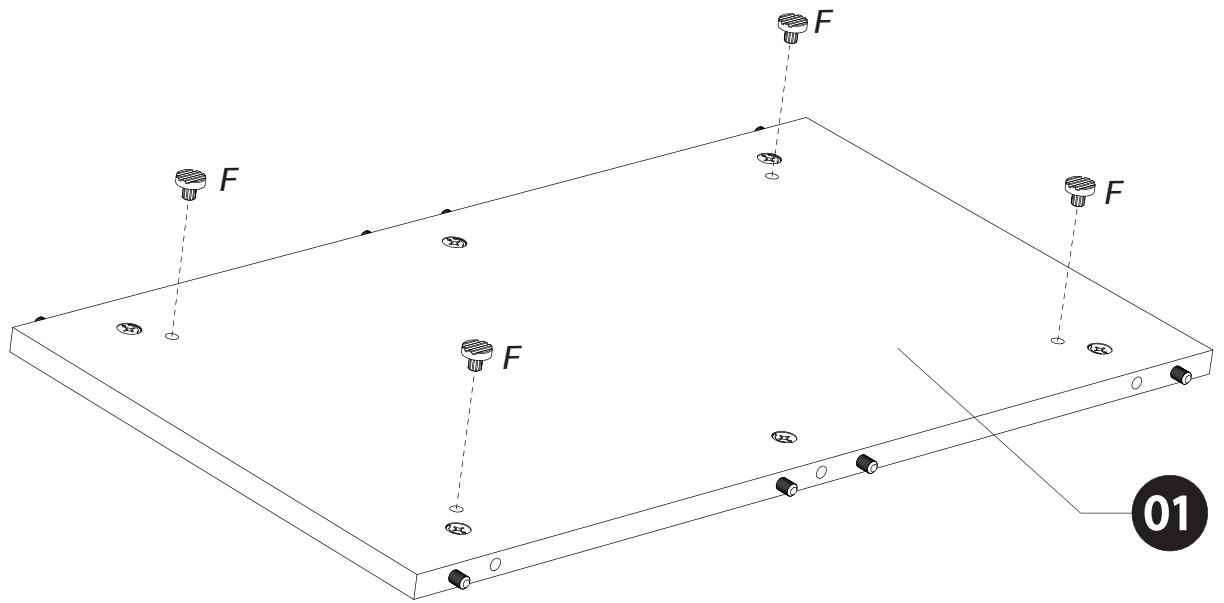

7

J - x4

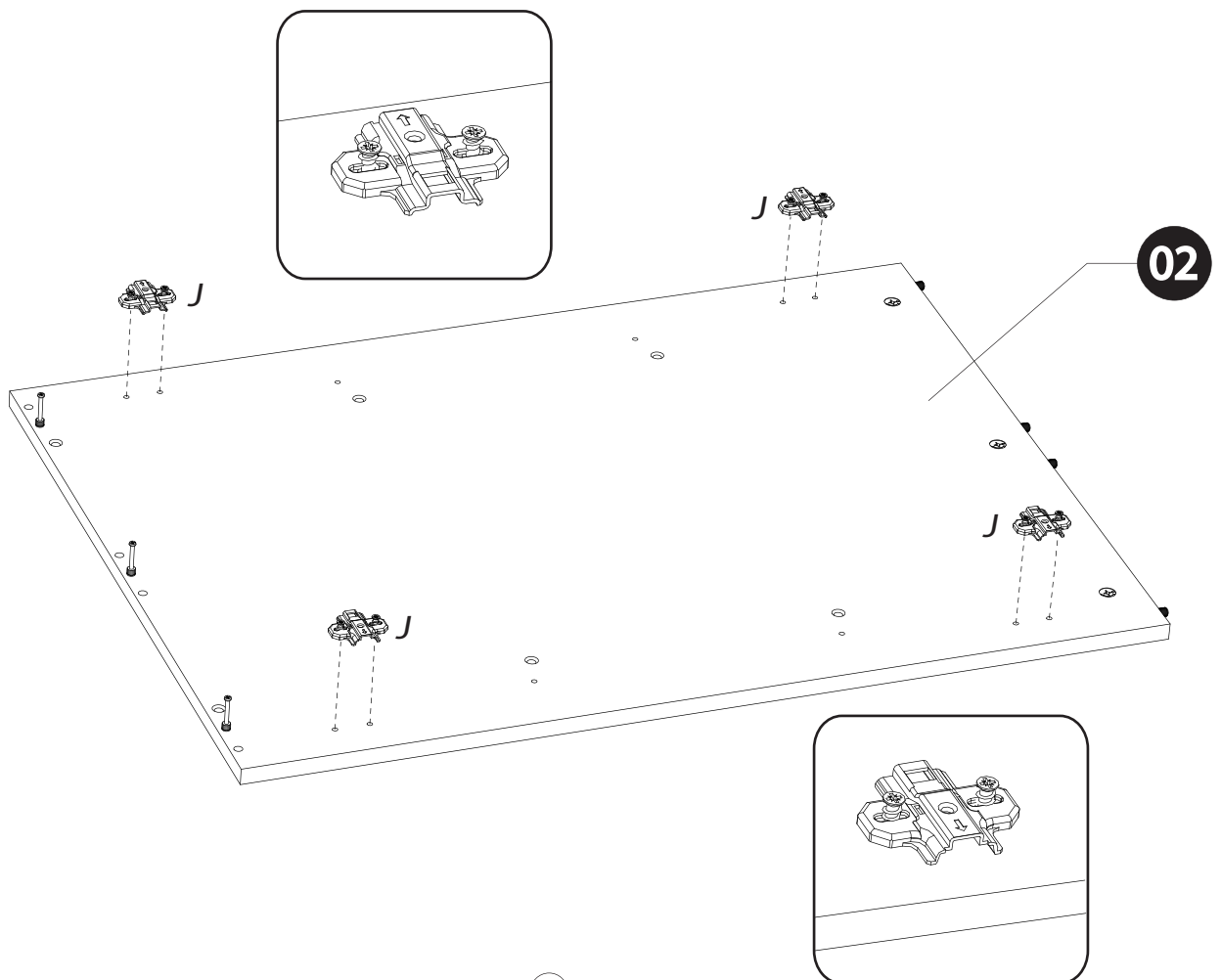
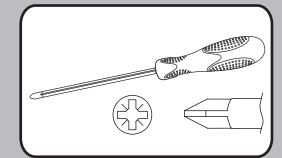
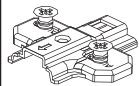



8

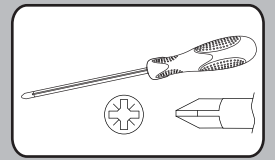
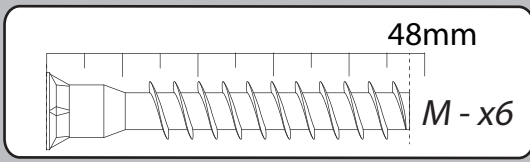

02

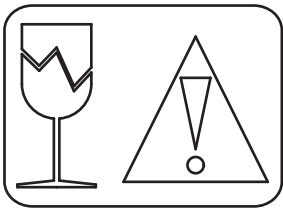
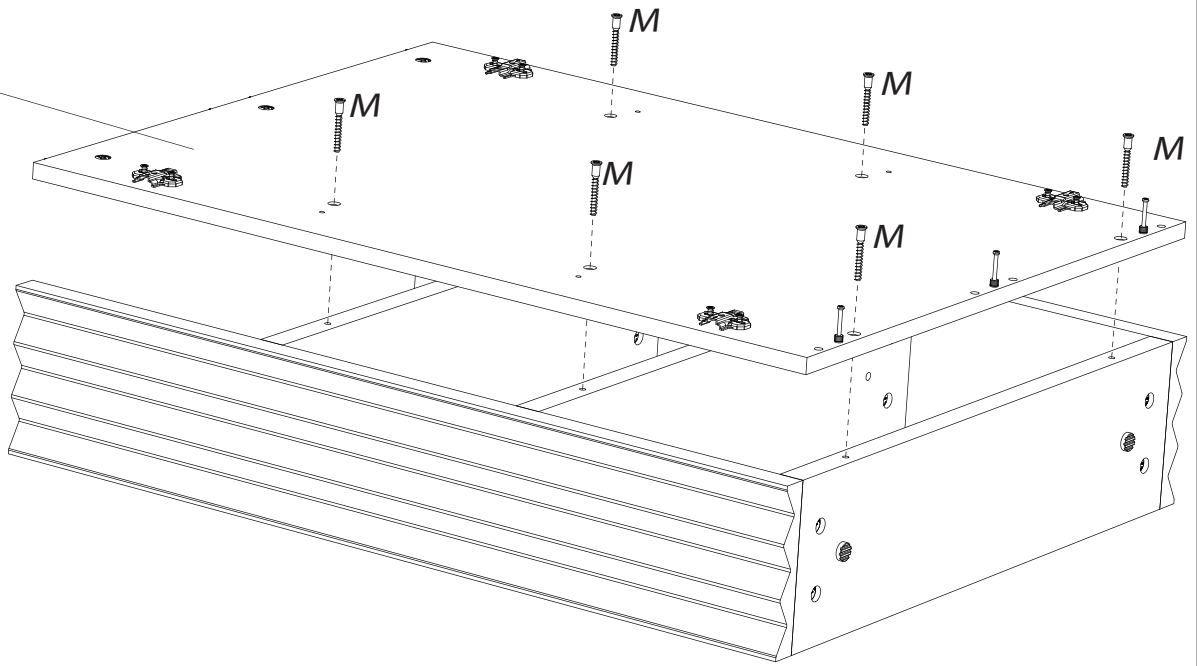

9

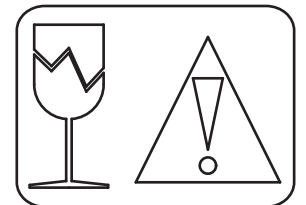
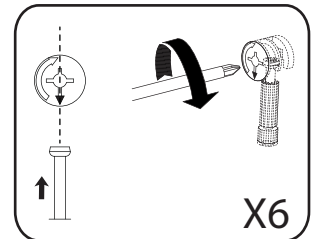
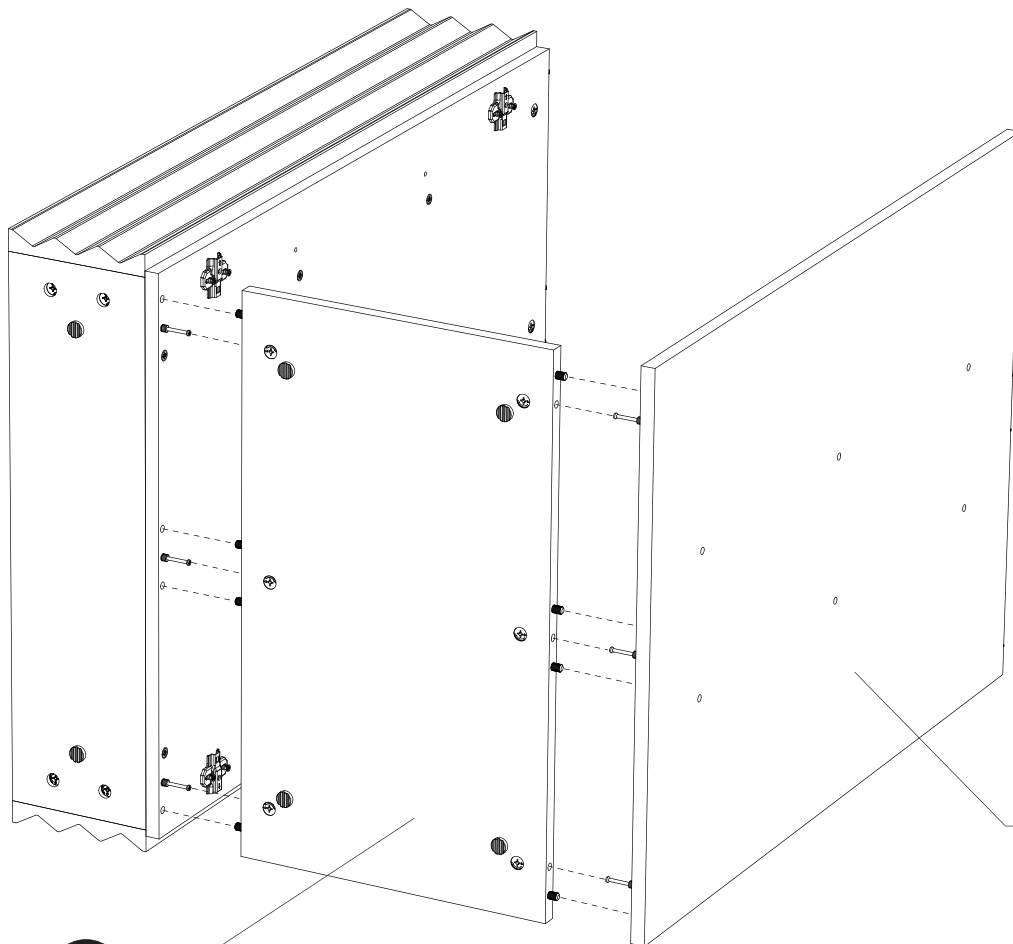
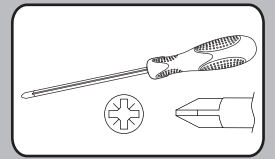
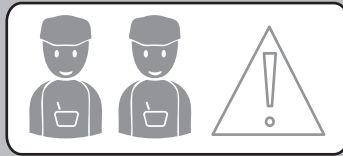

01

07

9

C-x28



B-x32

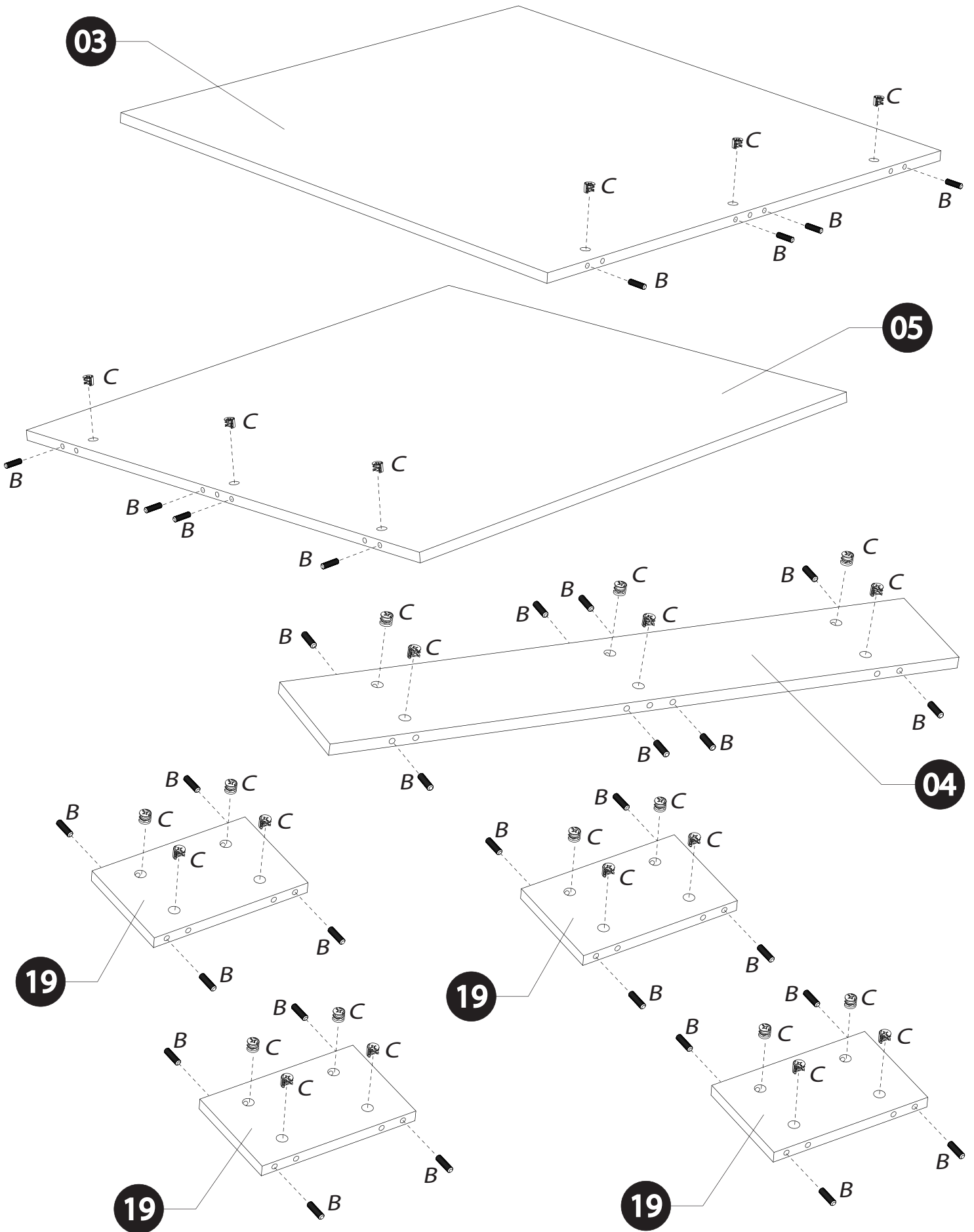
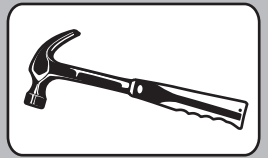

F-x6



A-x22

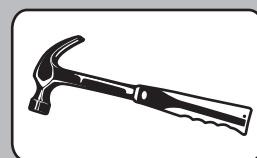
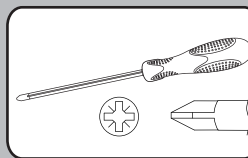

03

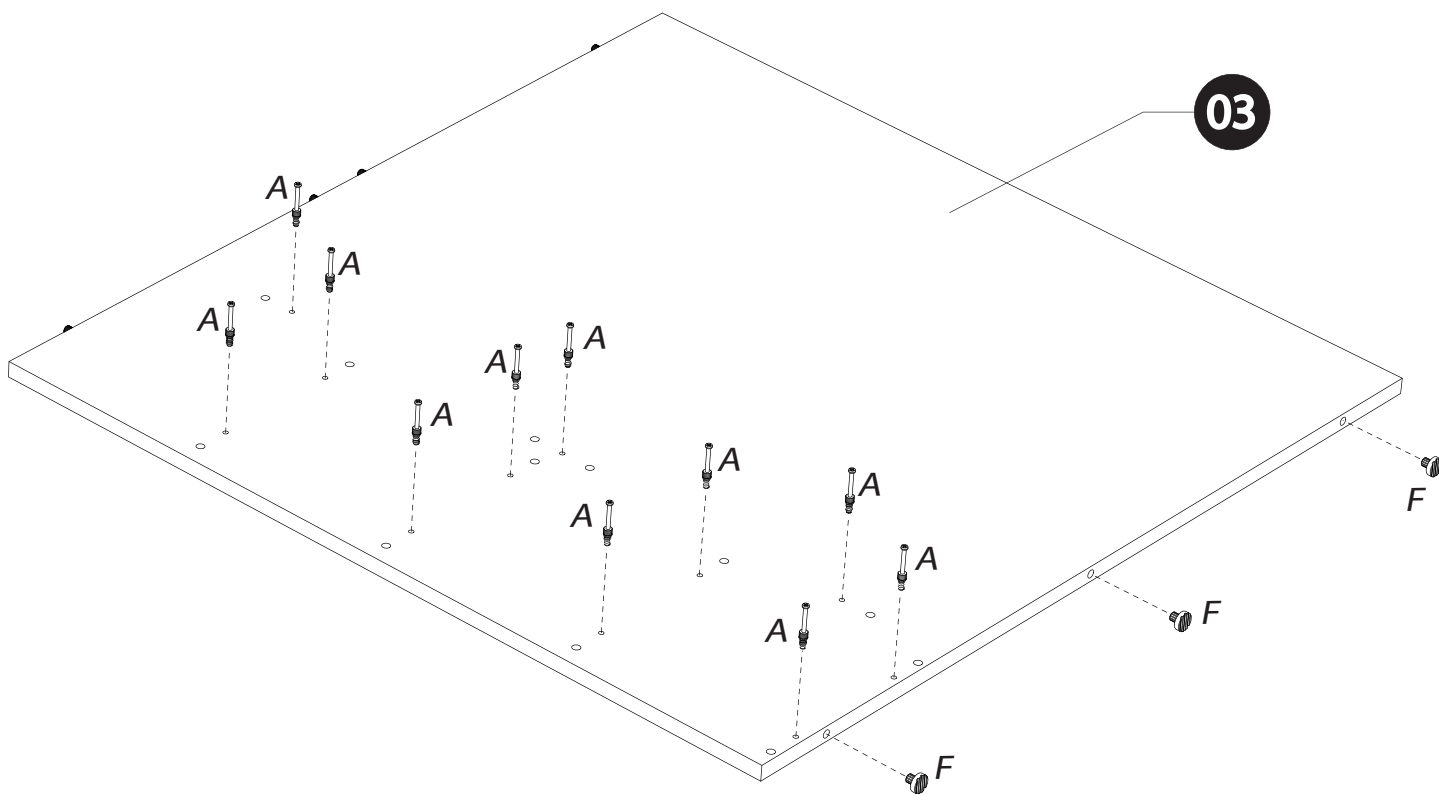

05

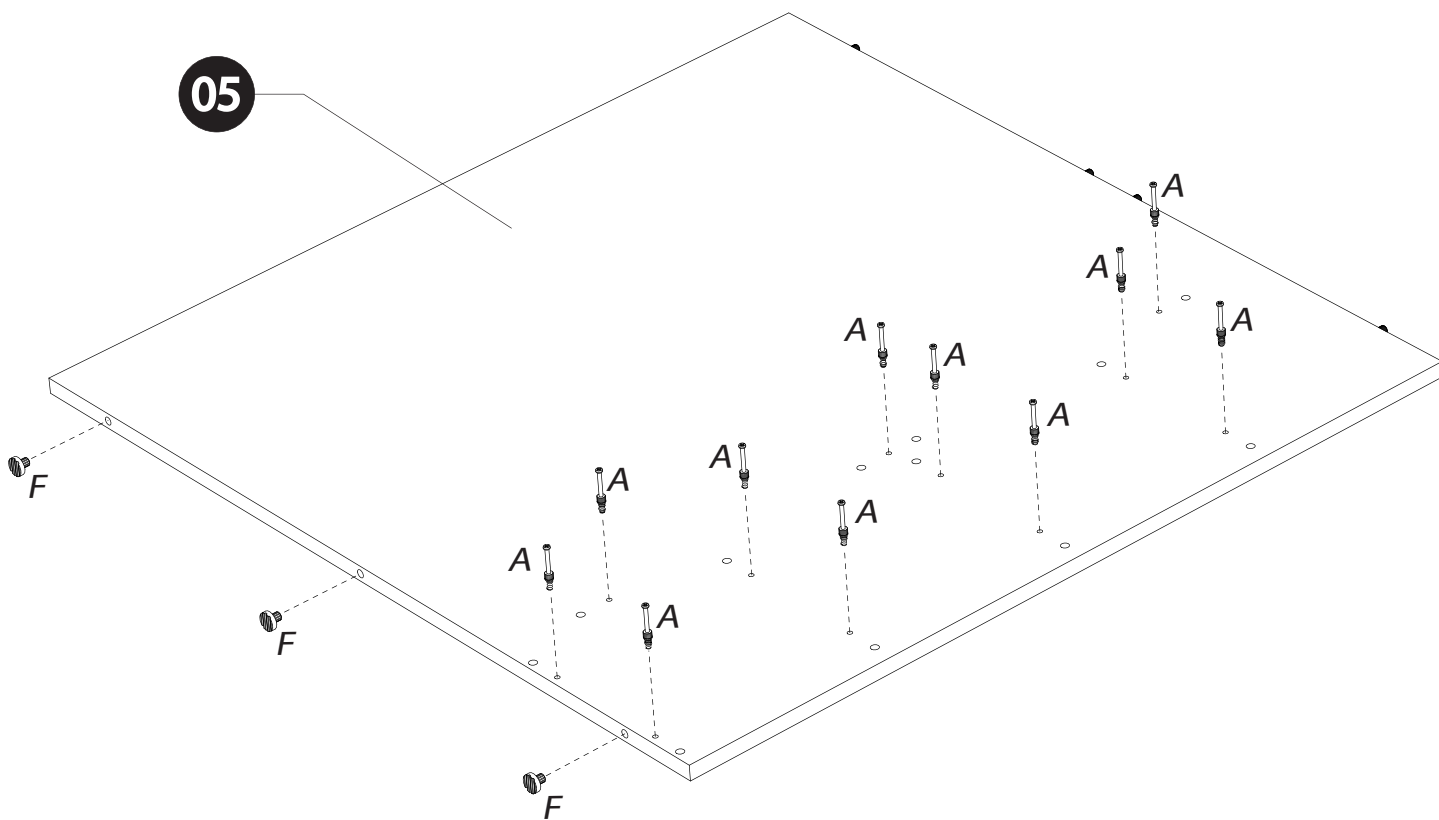

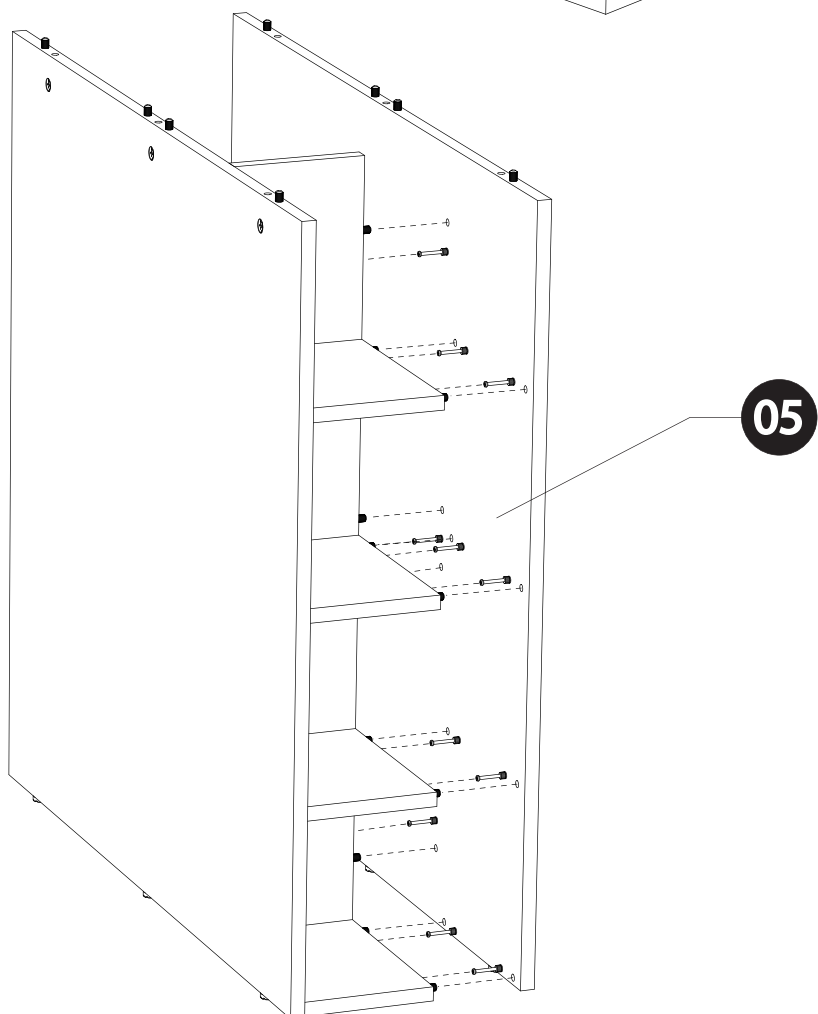
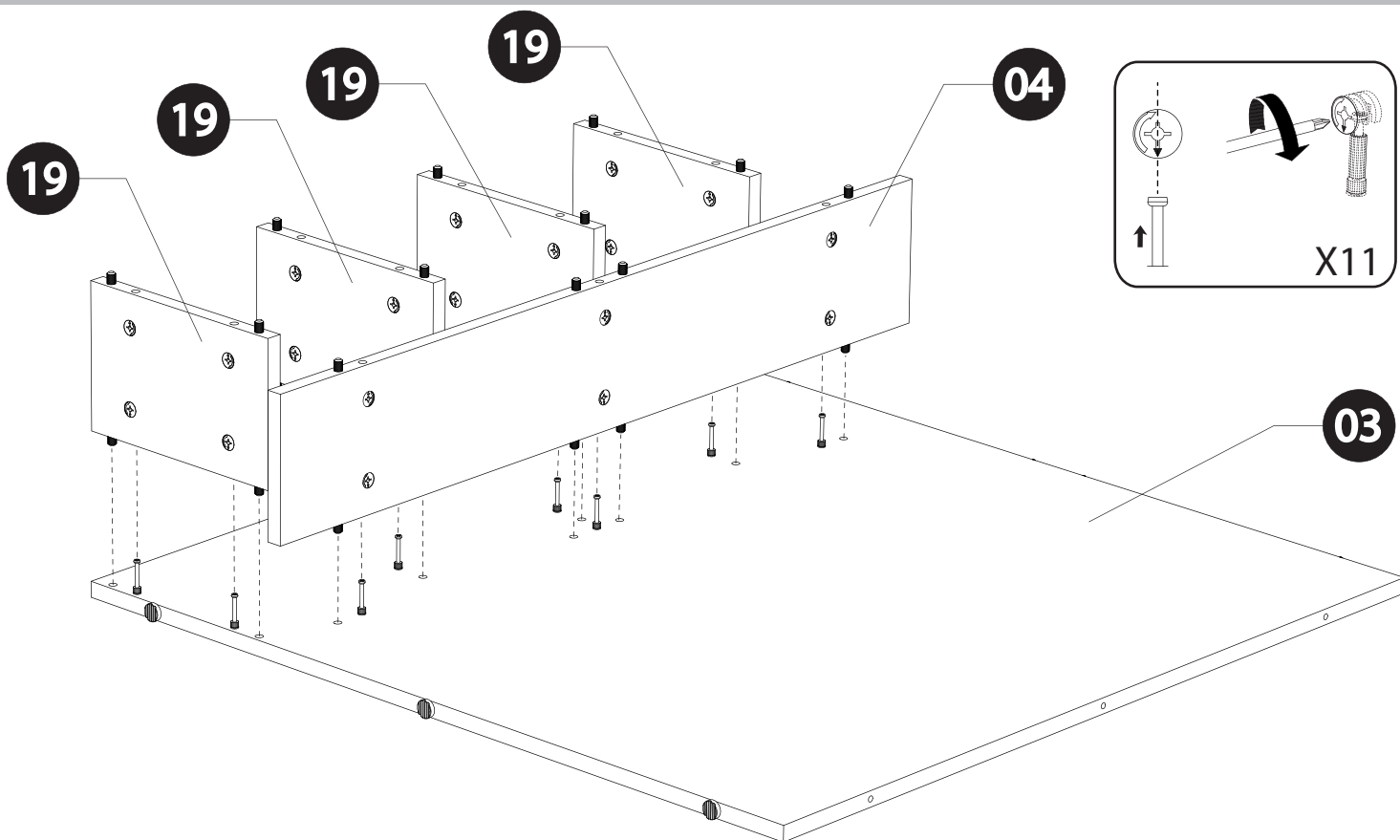
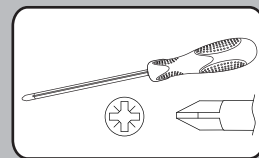
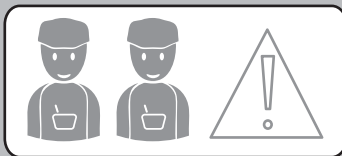



# 15

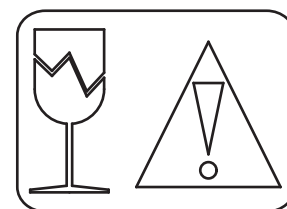
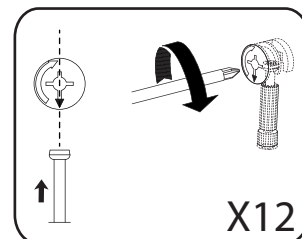
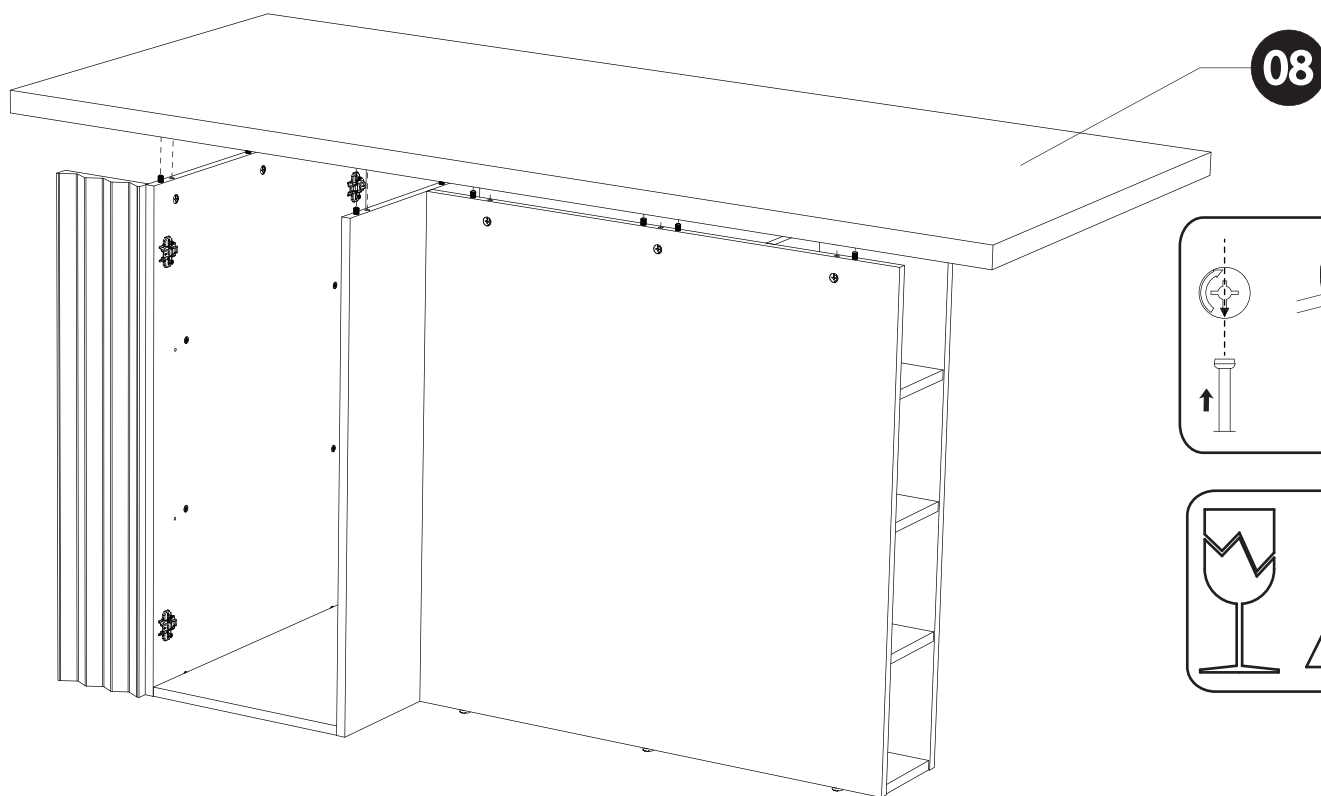
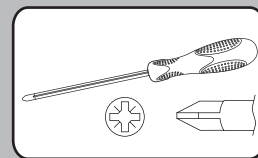
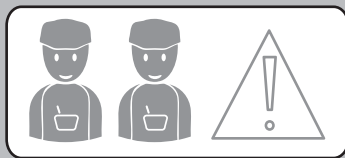

# 16

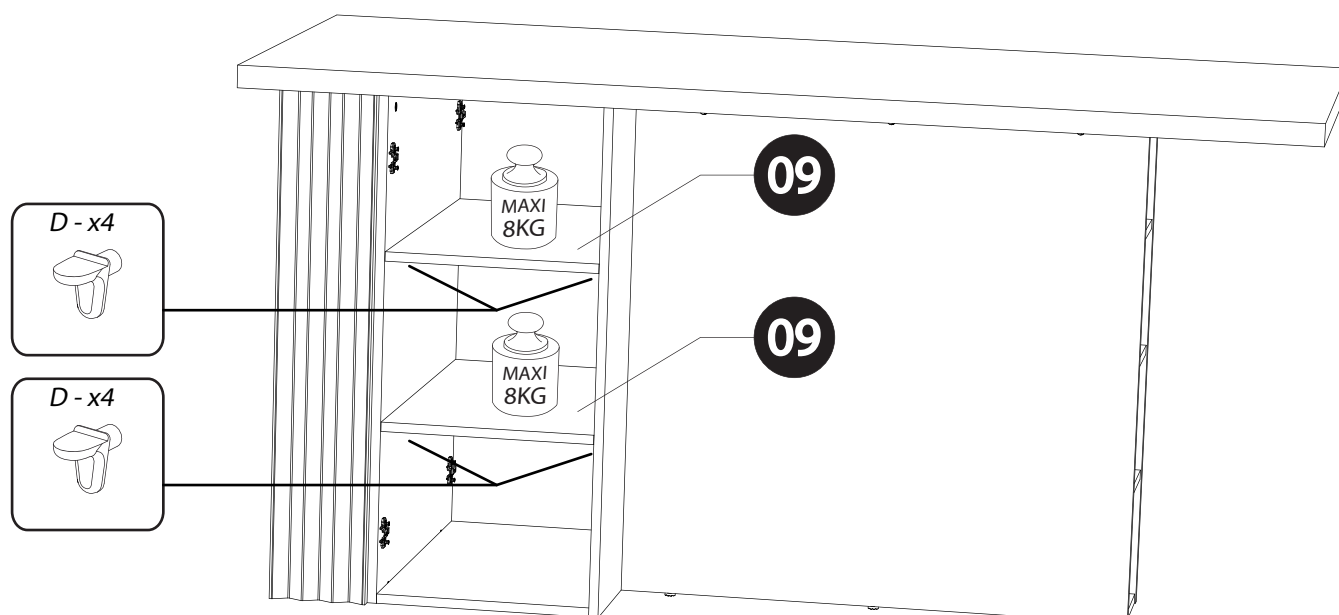
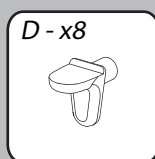

# 17

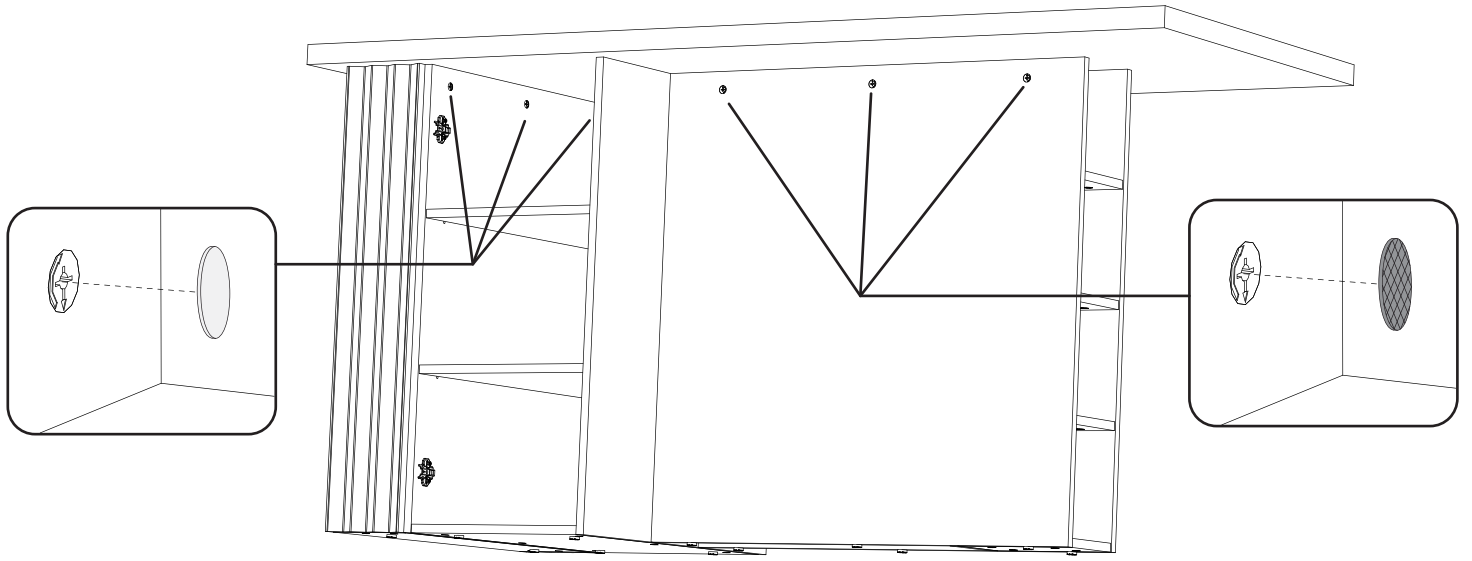
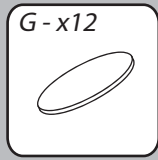
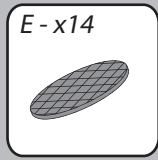

# 18

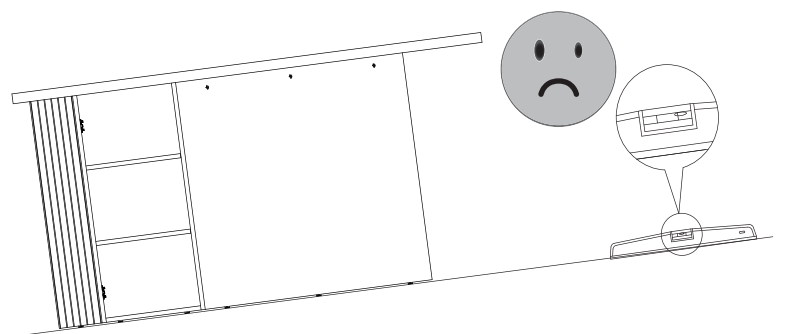
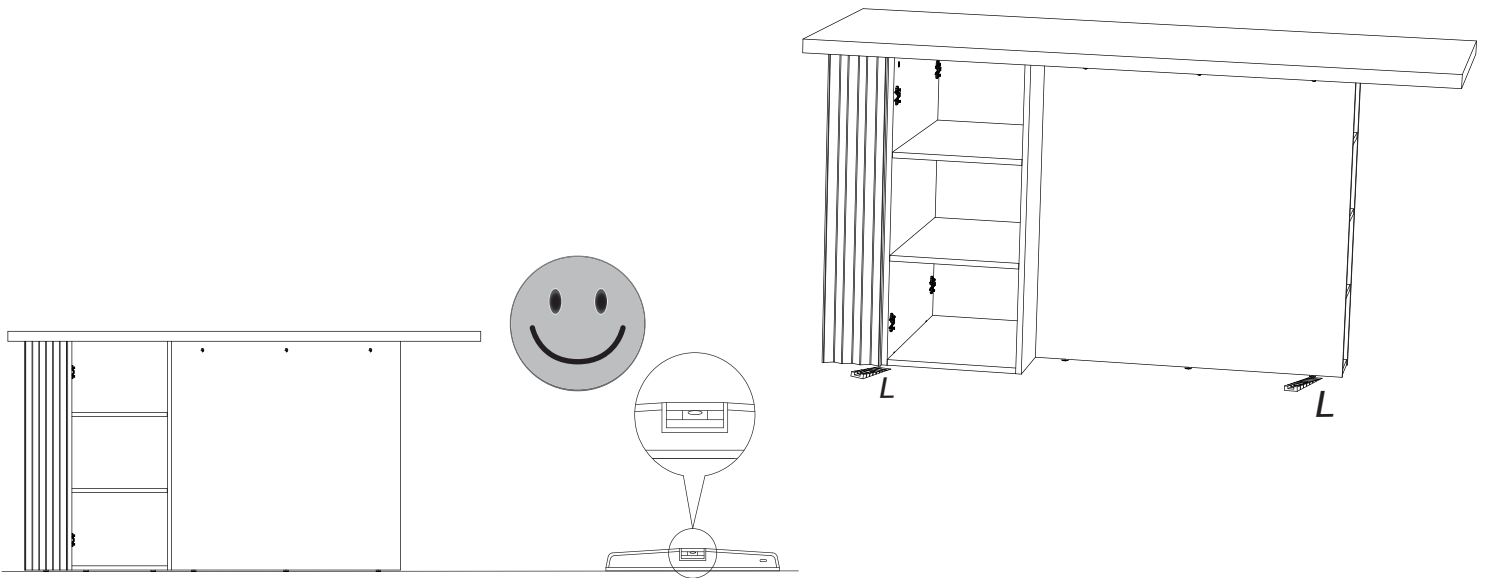
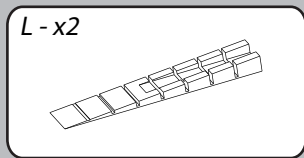

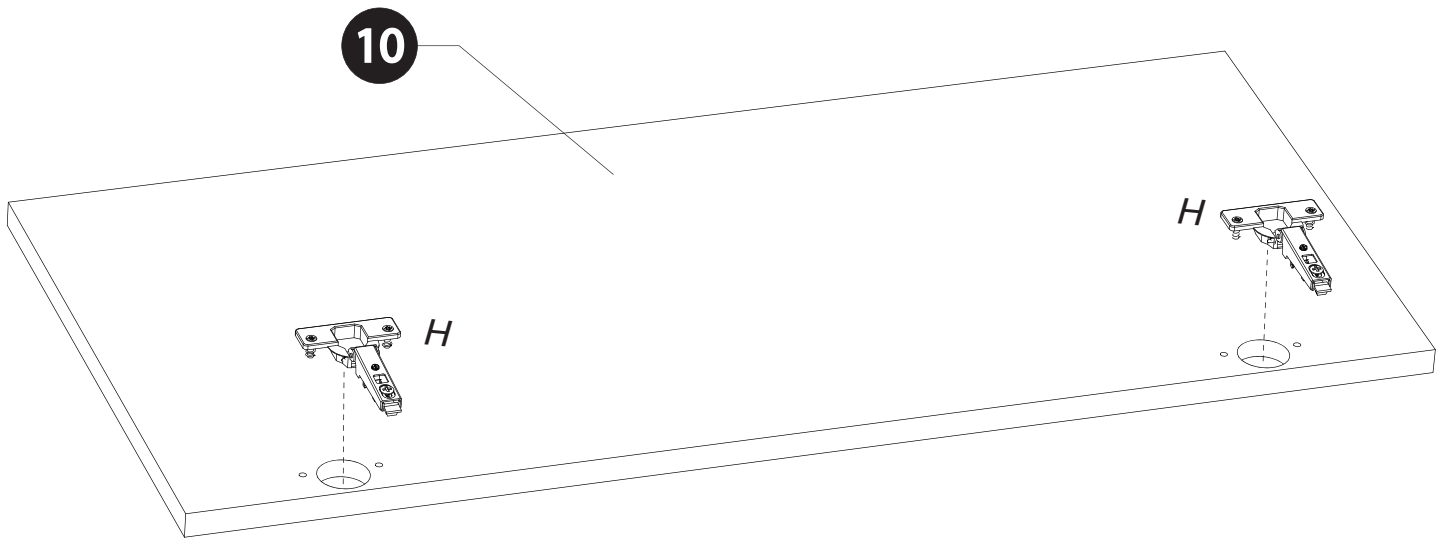
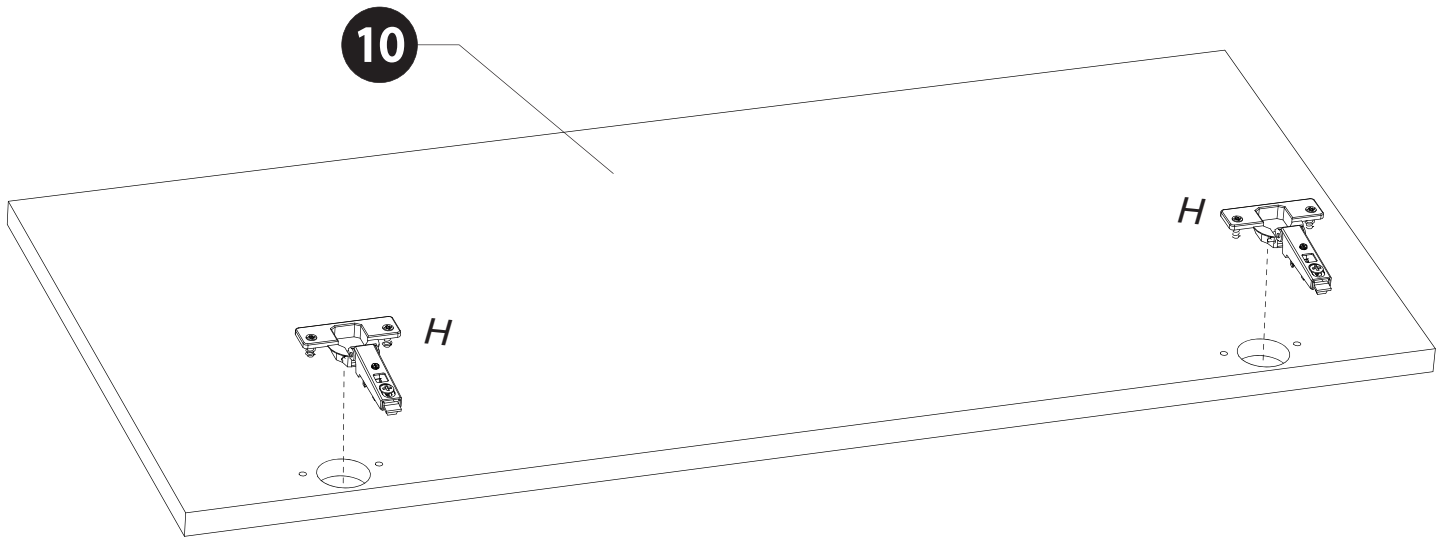
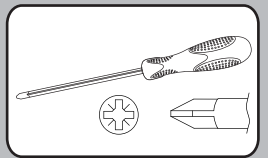
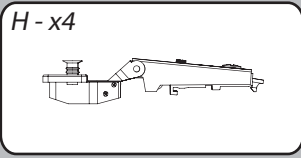



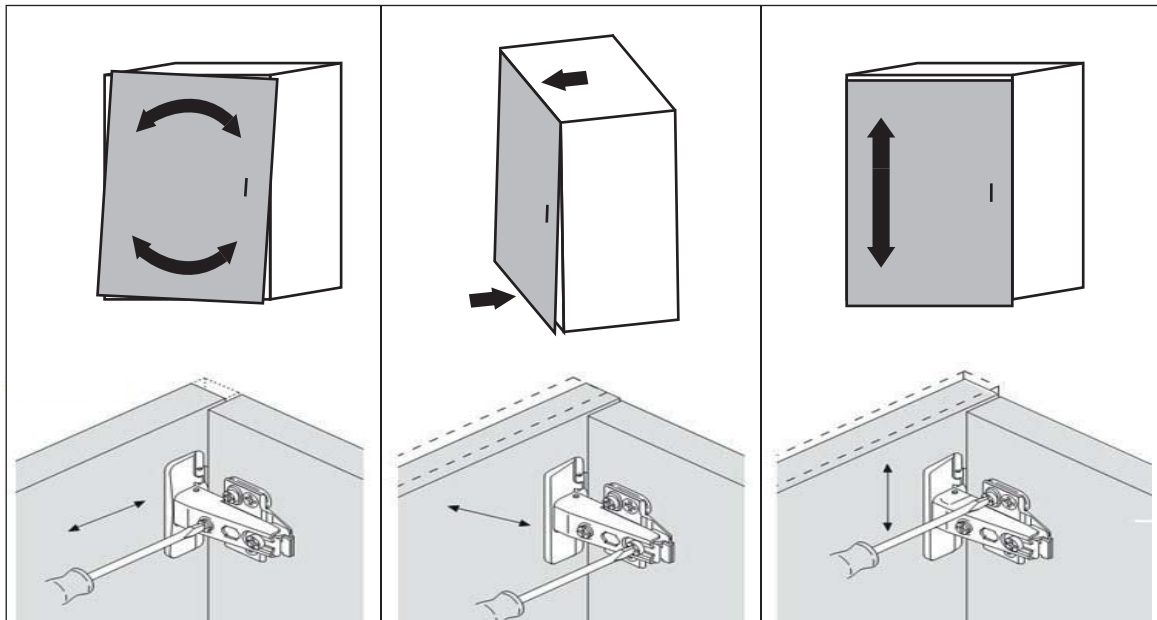
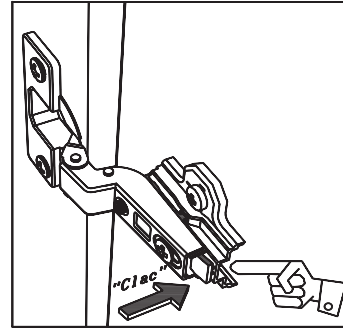
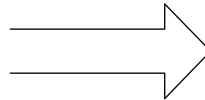
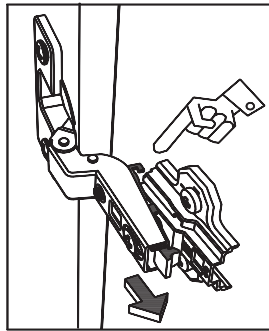
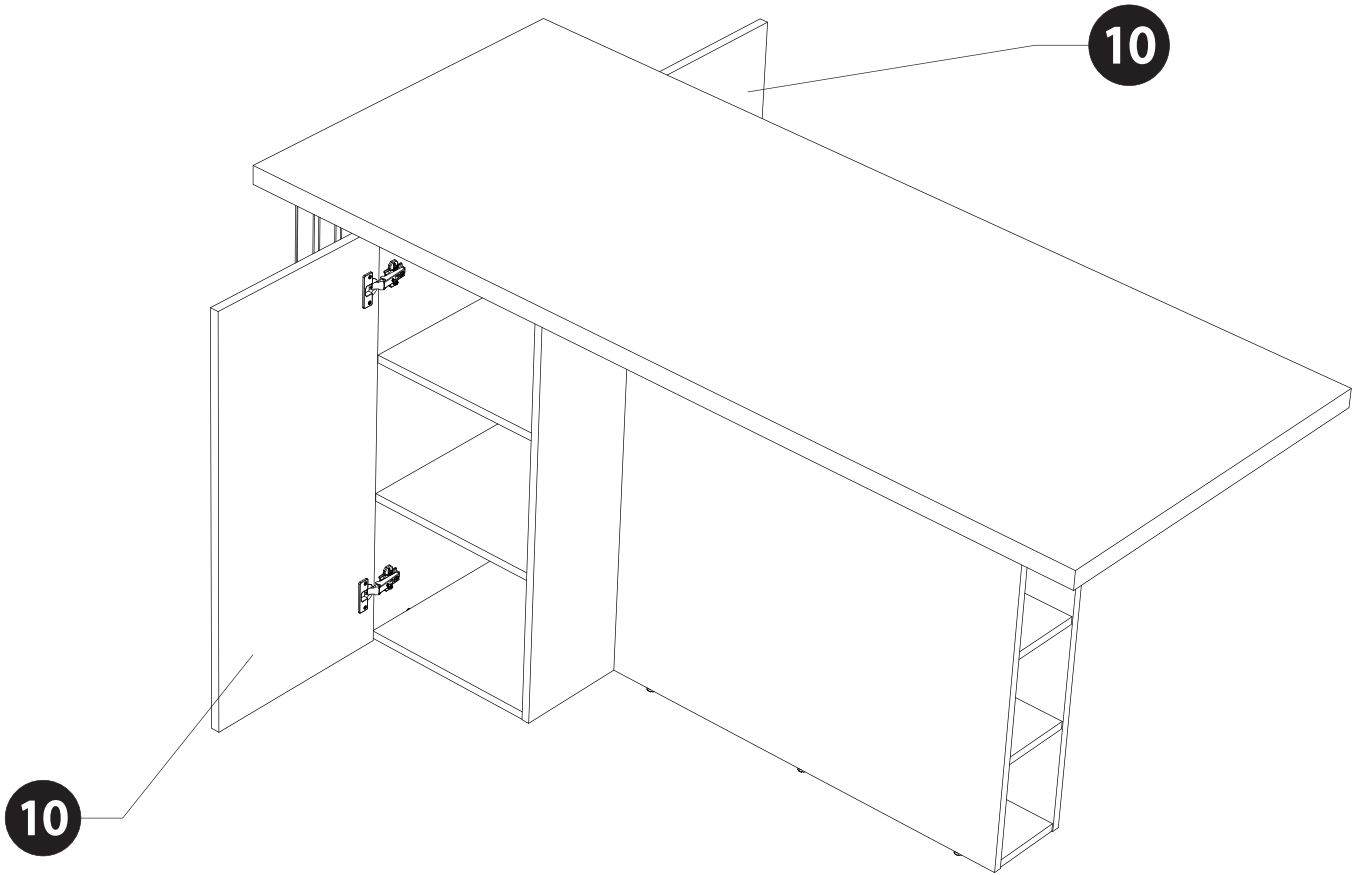
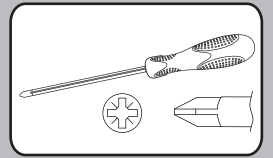

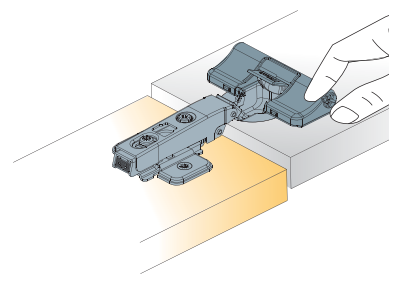
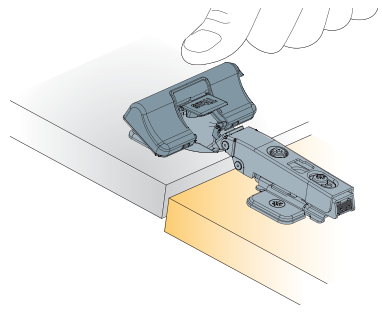
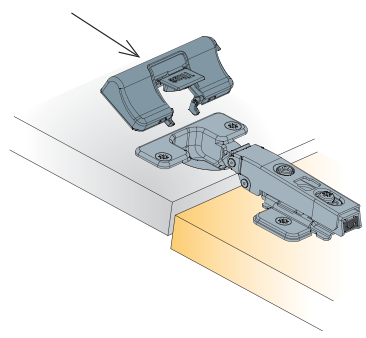
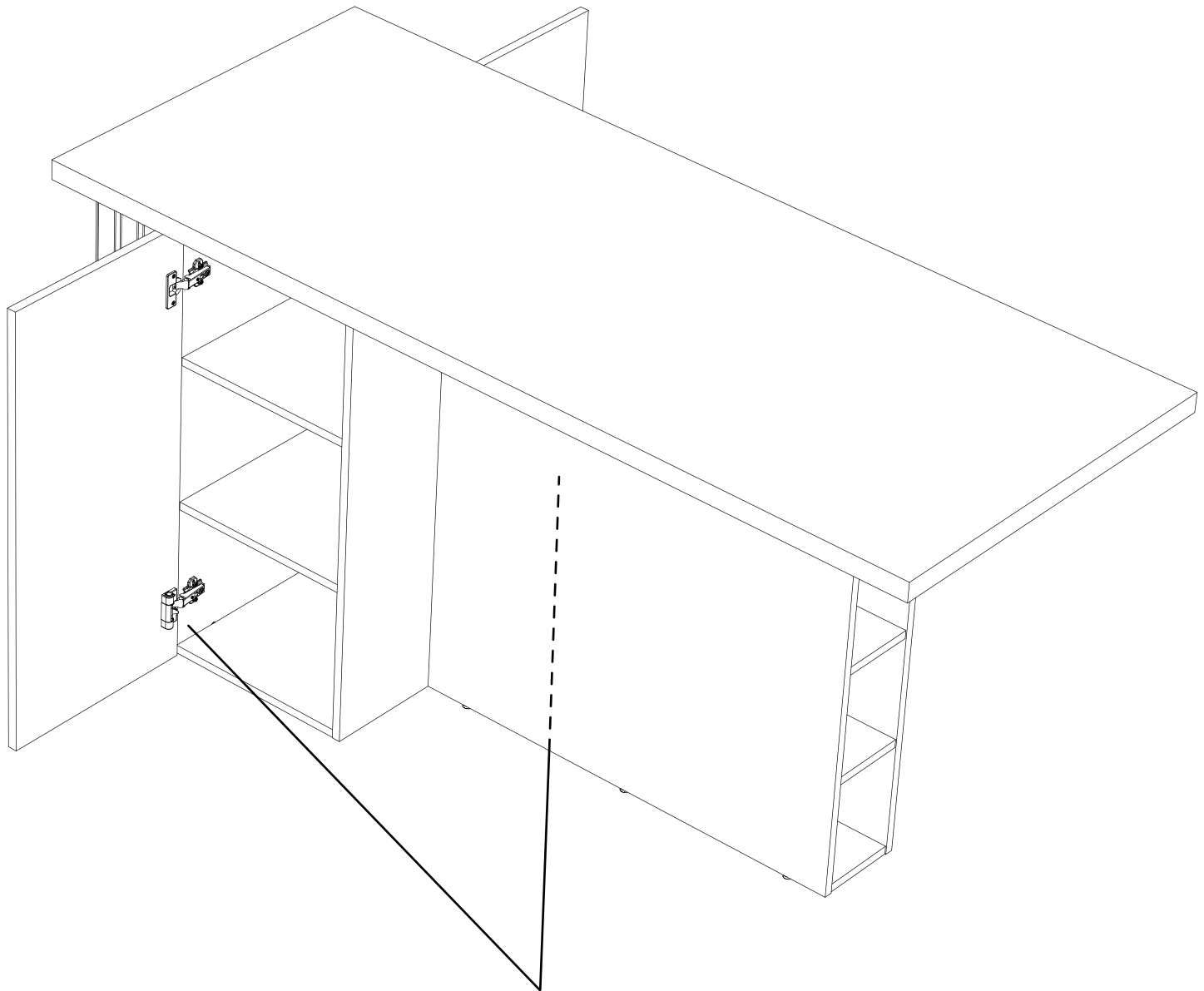
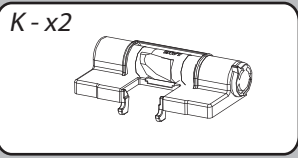

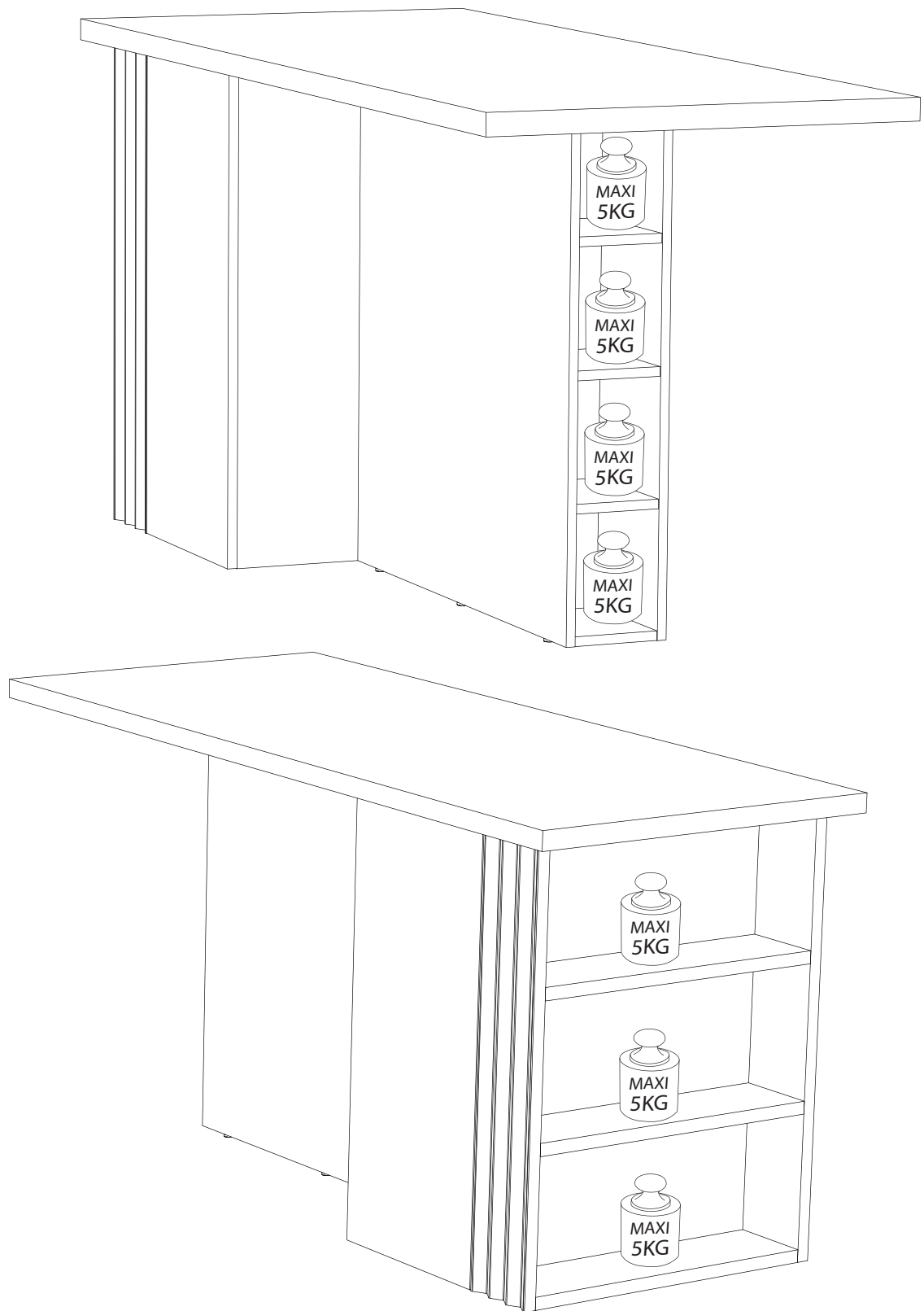

FRANCAIS

Recommandations de démontage :

En cas de déménagement, il convient de procéder au démontage de votre meuble, en ôtant toute la visserie.

ENGLISH

Disassembly advices:

In case of moving, it is needed to dismantle the furniture removing the fittings.

DEUTSCH

Empfehlungen für die Demontage:

Bei Transport bitte alle Beschläge demontieren.

## AROLLA 0636 :

Ilot central 2po composé de panneaux de particules revêtus papier décor Bangali Mango (Wengé) et de laque blanche brillante à l'extérieur. L'intérieur est revêtus papier Bangali Mango (Wengé).

L.180 cm - H.91.5 cm - P.75.5 cm.

A monter soi-même.

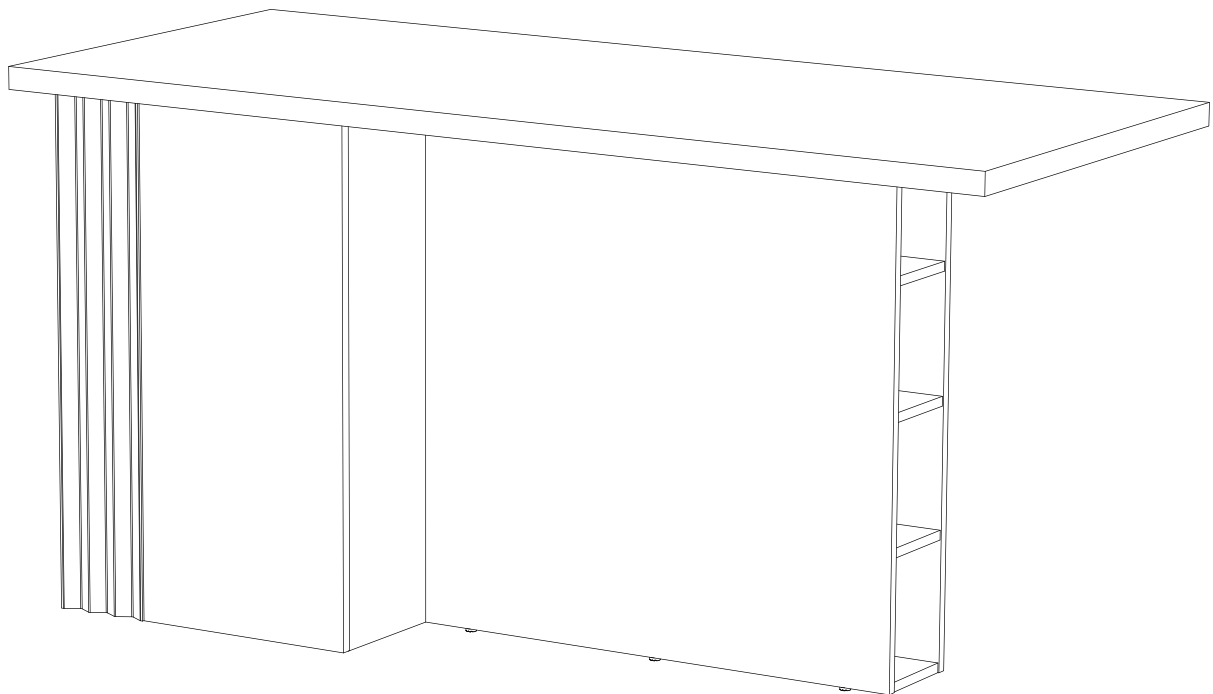

"Les meubles contenant des panneaux à base de bois (panneaux de particules, panneaux de fibres, contreplaqué...) peuvent émettre des substances polluantes dans l'air intérieur. Il est ainsi recommandé, après l'installation du meuble dans son logement, d'aérer fréquemment la pièce concernée pendant au moins quatre semaines afin de réduire son exposition aux polluants émis par le meuble."